

175, 177, & 179

True RMS Multimeters

Calibration Information

Introduction

⚠ ⚠ Warning

To avoid electric shock or injury, do not perform the performance tests or calibration adjustment procedures unless qualified to do so.

The information provided in this document is for the use of qualified personnel only.

The *175, 177, & 179 Calibration Information* provides the information necessary to adjust and verify the performance of the Fluke Models 175, 177, and 179 True RMS Multimeters (hereafter known as the Meter).

The following information is included in this document:

- Safety Information and International Electrical Symbols (page 2)
- Test Lead Alert (page 3)
- Specifications (pages 4-6)
- Testing and Replacing the Fuses (pages 7-8)
- Replacing the Battery (page 8)
- Cleaning (page 9)
- Replacing the LCD (page 9-10)
- Performance Tests (pages 10-15)
- Calibration Adjustment (pages 15-18)
- User-Replaceable Parts and Accessories (pages 19-20)
- Complete Warranty (page 21)

See the *175, 177, & 179 Users Manual* for complete operating instructions.

Service Information

To contact Fluke, call one of the following telephone numbers:

USA: 1-888-99-FLUKE (1-888-993-5853)
Canada: 1-800-36-FLUKE (1-800-363-5853)
Europe: +31 402-675-200
Japan: +81-3-3434-0181
Singapore: +65-738-5655
Anywhere in the world: +1-425-446-5500

Or, visit Fluke's Web site at www.fluke.com.

To register your product, visit register.fluke.com

Safety Information

"Warning" and "Caution" Statements

A "⚠️⚠️ Warning" identifies hazardous conditions and actions that could cause bodily harm or death.

A "⚠️ Caution" identifies conditions and actions that could damage the Meter, the equipment under test, or cause permanent loss of data.















⚠️⚠️ Warnings and Precautions

To avoid possible electric shock or personal injury, and to avoid possible damage to the Meter or to the equipment under test, adhere to the following practices:

- Use this meter only as specified in this manual or the protection provided by the Meter might be impaired.
- Before using the Meter, inspect the case. Do not use the Meter if it is damaged. Look for cracks or missing plastic. Pay particular attention to the insulation around the connectors.
- Inspect the test leads for damaged insulation or exposed metal. Check the test leads for continuity. Replace damaged test leads before using the Meter.
- Verify the Meter's operation by measuring a known voltage. Do not use the Meter if it operates abnormally. Protection may be impaired. When in doubt, have the Meter serviced.
- Do not apply more than the rated voltage, as marked on the Meter, between the terminals or between any terminal and earth ground.
- Use caution when working with voltages above 30 V ac rms, 42 V ac peak, or 60 V dc. These voltages pose a shock hazard.
- Use the proper terminals, function, and range for your measurements.
- Do not operate the Meter around explosive gas, vapor, or dust.
- When using the probes, keep fingers behind the finger guards.
- When making connections, connect the common test lead before connecting the live test lead; when disconnecting, disconnect the live test lead before disconnecting the common test lead.
- Disconnect circuit power and discharge all high-voltage capacitors before testing resistance, continuity, diodes, or capacitance.
- Before measuring current, check the Meter's fuses (see "Testing the Fuses") and turn OFF power to the circuit before connecting the Meter to the circuit.
- Do not operate the Meter with the case (or part of the case) removed.
- Use only a single 9 V battery, properly installed in the Meter case, to power the Meter.
- Replace the battery as soon as the low battery indicator (🔋) appears. With a low battery, the Meter might produce false readings that can lead to electric shock and personal injury.
- Remove test leads from the Meter before opening the Meter case.
- When servicing the Meter, use only specified replacement parts.
- When replacing the fuses, use ONLY replacement fuses with the amperage, interrupt, voltage, and speed ratings specified in Table 5.

International Electrical Symbols

The following international symbols appear in this document and on the Meter.

	AC (Alternating Current)		Earth ground
	DC (Direct Current)		Fuse
	AC or DC		Conforms to European Union directives
	Risk of danger. Important Information. Refer to the manual.		Conforms to relevant Canadian Standards Association directives
	Hazardous Voltage		Double insulated
	<i>Technischer Überwachungs Verein.</i> German certifying body.		Underwriters Laboratories, Inc. Meter in accordance with IEC 61010-1. 54CJ
	Battery. Low Battery when shown on display.		Conforms to relevant Australian standards
	<i>Verband Deutscher Elektroniker.</i> German electronics association.		

Test Lead Alert

Warning

Personal injury or damage to the Meter can occur if the user attempts to make a measurement with a lead in an incorrect terminal.

As a reminder to check that the test leads are in the correct terminals, **LEAD** is displayed when the Rotary Switch is moved to or from the **mA** or **A** position.

Specifications

Accuracy is specified for 1 year after calibration, at operating temperatures of 18 °C to 28 °C, with relative humidity at 0 % to 95 %. Accuracy specifications take the form of: \pm ([% of Reading] + [Counts]). AC conversions are ac-coupled, true rms responding.

Maximum voltage between any terminal and earth ground:	1000 V dc or ac rms
Surge Protection:	8 kV peak per IEC 61010
⚠ Fuse for mA inputs:	440 mA, 1000 V FAST Fuse, minimum interrupt rating 10 kA
⚠ Fuse for A input:	11 A, 1000 V FAST Fuse, minimum interrupt rating 17 kA
Display:	Digital: 6000 counts, updates 4/sec Bar Graph: 33 segments; Updates 40/sec Frequency: 10,000 counts Capacitance: 1,000 counts
Altitude:	Operating: 2000 m; Storage: 12,000 m
Temperature:	Operating: -10 °C to +50 °C; Storage: -40 °C to +60 °C
Temperature coefficient:	0.1 X (specified accuracy) / °C (< 18 °C or > 28 °C)
Electromagnetic Compatibility (EN 61326-1:1997):	In an RF field of 3 V/M, accuracy = specified accuracy except in temperature: specified accuracy \pm 5 °C (9 °F)
Relative Humidity:	Maximum, Noncondensing 90 % to 35 °C 75 % to 40 °C 45 % to 50 °C
Battery Life:	Alkaline: 300 hrs typical
Size (H x W x L):	4.3 cm x 9 cm x 18.5 cm
Weight:	420 g
Safety Compliances:	ANSI/ISA S82.02.01, CSA C22.2-1010.1, IEC 61010 to 1000 V Measurement Category III, 600 V Measurement Category IV CAT III- Equipment designed to protect against transients in equipment in fixed-equipment installations, such as distribution panels, feeders and short branch circuits, and lighting systems in large buildings. CAT IV- Equipment designed to protect user against transients from the primary supply level, such as an electricity meter or an overhead or underground utility service.
Certifications:	CSA, TÜV (EN61010), CE,  (N10140), VDE, UL

True RMS Multimeters
Specifications

Function	Range ¹	Resolution	Accuracy ± ([% of Reading] + [Counts])		
			Model 175	Model 177	Model 179
AC Volts ^{2,3}	600.0 mV	0.1 mV	1.0 % + 3	1.0 % + 3	1.0 % + 3
	6.000 V 60.00 V 600.0 V 1000 V	0.001 V 0.01 V 0.1 V 1 V	(45 Hz to 500 Hz) 2.0 % + 3 (500 Hz to 1 kHz)	(45 Hz to 500 Hz) 2.0 % + 3 (500 Hz to 1 kHz)	(45 Hz to 500 Hz) 2.0 % + 3 (500 Hz to 1 kHz)
DC mV	600.0 mV	0.1 mV	0.15 % + 2	0.09 % + 2	0.09 % + 2
DC Volts	6.000 V 60.00 V 600.0 V	0.001 V 0.01 V 0.1 V	0.15 % + 2	0.09 % + 2	0.09 % + 2
	1000 V	1 V	0.15 % + 2	0.15 % + 2	0.15 % + 2
Continuity	600 Ω	1 Ω	Meter beeps at < 25 Ω, beeper turns off at > 250 Ω; detects opens or shorts of 250 μs or longer.		
Ohms	600.0 Ω	0.1 Ω	0.9 % + 2	0.9 % + 2	0.9 % + 2
	6.000 kΩ	0.001 kΩ	0.9 % + 1	0.9 % + 1	0.9 % + 1
	60.00 kΩ	0.01 kΩ	0.9 % + 1	0.9 % + 1	0.9 % + 1
	600.0 kΩ	0.1 kΩ	0.9 % + 1	0.9 % + 1	0.9 % + 1
	6.000 MΩ	0.001 MΩ	0.9 % + 1	0.9 % + 1	0.9 % + 1
	50.00 MΩ	0.01 MΩ	1.5 % + 3	1.5 % + 3	1.5 % + 3
Diode test	2.400 V	0.001 V	1 % + 2		
Capacitance	1000 nF	1 nF	1.2 % + 2	1.2 % + 2	1.2 % + 2
	10.00 μF	0.01 μF	1.2 % + 2	1.2 % + 2	1.2 % + 2
	100.0 μF	0.1 μF	1.2 % + 2	1.2 % + 2	1.2 % + 2
	9999 μF ⁴	1 μF	10 % typical	10 % typical	10 % typical
AC Amps ⁵ (True RMS) (45 Hz to 1 kHz)	60.00 mA	0.01 mA	1.5 % + 3	1.5 % + 3	1.5 % + 3
	400.0 mA	0.1 mA			
	6.000 A	0.001 A			
	10.00 A	0.01 A			

1. All AC voltage and AC current ranges are specified from 5 % of range to 100 % of range.
2. Crest factor of ≤ 3 at full scale up to 500 V, decreasing linearly to crest factor ≤ 1.5 at 1000 V.
3. For non-sinusoidal waveforms, add -(2% reading + 2% full scale) typical, for crest factors up to 3.
4. In the 9999 μF range for measurements to 1000 μF, the measurement accuracy is 1.2 % + 2 for all models.
5. Amps input burden voltage (typical): 400 mA input 2 mV/mA, 10 A input 37 mV/A.

Function	Range ¹	Resolution	Accuracy ± ([% of Reading] + [Counts])		
			Model 175	Model 177	Model 179
DC Amps ⁶	60.00 mA 400.0 mA 6.000 A 10.00 A	0.01 mA 0.1 mA 0.001 A 0.01 A	1.0 % + 3	1.0 % + 3	1.0 % + 3
Hz (AC- or DC-coupled, V or A ^{2,3,4,5} input)	99.99 Hz 999.9 Hz 9.999 kHz 99.99 kHz	0.01 Hz 0.1 Hz 0.001 kHz 0.01 kHz	0.1 % + 1	0.1 % + 1	0.1 % + 1
Temperature	-40 °C to +400 °C -40 °F to +752 °F	0.1 °C 0.1 °F	NA	NA	1 % + 10 ⁷ 1 % + 18 ⁷
MIN MAX AVG	For DC functions, accuracy is the specified accuracy of the measurement function ± 12 counts for changes longer than 275 ms in duration. For AC functions, accuracy is the specified accuracy of the measurement function ± 40 counts for changes longer than 1.2 s in duration.				
1. All AC voltage and AC current ranges are specified from 5 % of range to 100 % of range. 2. Frequency is specified from 2 Hz to 99.99 kHz in Volts and from 2 Hz to 30 kHz in Amps. 3. For serial number 83911000 and below, frequencies < 10 kHz are not specified in 600 mV ac, 60 mA ac, and 6 A ac ranges. For Serial numbers between 83911001 – 83911240 and 84060001 and above, this note does not apply . 4. Below 2 Hz, the display shows zero Hz. 5. Noise at frequencies below 4.5 Hz and amplitude below 600 mV may exceed the frequency specification. 6. Amps input burden voltage (typical): 400 mA input 2 mV/A, 10 A input 37 mV/A. 7. Does not include error of the thermocouple probe.					

Function	Overload Protection ¹	Input Impedance (Nominal)	Common Mode Rejection Ratio (1 kΩ Unbalanced)		Normal Mode Rejection
Volts AC	1000 V rms	> 10 MΩ < 100 pF	> 60 dB @ dc, 50 Hz or 60 Hz		
Volts DC	1000 V rms	> 10 MΩ < 100 pF	> 120 dB @ dc, 50 Hz or 60 Hz		> 60 dB @ 50 Hz or 60 Hz
mV/μ	1000 V rms ²	> 10 MΩ < 100 pF	> 120 dB @ dc, 50 Hz or 60 Hz		> 60 dB @ 50 Hz or 60 Hz
		Open Circuit Test Voltage	Full Scale Voltage To: 600 kΩ 50 MΩ		Short Circuit Current
Ohms/Continuity	1000 V rms ²	< 8.0 V dc	< 660 mV dc	< 4.6 V dc	< 1.1 mA
Continuity/Diode test	1000 V rms ²	< 8.0 V dc	2.4 V dc		< 1.1 mA
1. 10 ⁷ V-Hz maximum. 2. For circuits < 0.3 A short circuit. 660 V for high energy circuits.					

Function	Overload Protection	Overload
mA	Fused, 440 mA, 1000 V FAST Fuse	600 mA overload for 2 minutes maximum
A	Fused, 11 A, 1000 V FAST Fuse	20 A overload for 30 seconds maximum

Testing the Fuses

⚠⚠ Warning

To avoid electrical shock or personal injury:

- Remove the test leads and any input signals before replacing the battery or fuses.
- To avoid electrical shock, arc blast, or damage to the Meter, install only fuses with the amperage, interrupt, voltage, and speed ratings specified in Table 5.

To test the fuses (refer to Figure 1):

1. Set the Rotary Switch to Ω .
 2. Plug a test lead into the **V Ω →** terminal and touch the probe to the **400 mA** (to test the 440 mA Fuse) or **10 A** terminal (to test the 11 A Fuse).
- If the display shows a resistance value in the range shown in Figure 1, the fuse is good.
 - If the display reads **OL**, replace the fuse and test again.
 - If the display shows any other value, have the Meter serviced. See “Service Information” earlier in this manual.

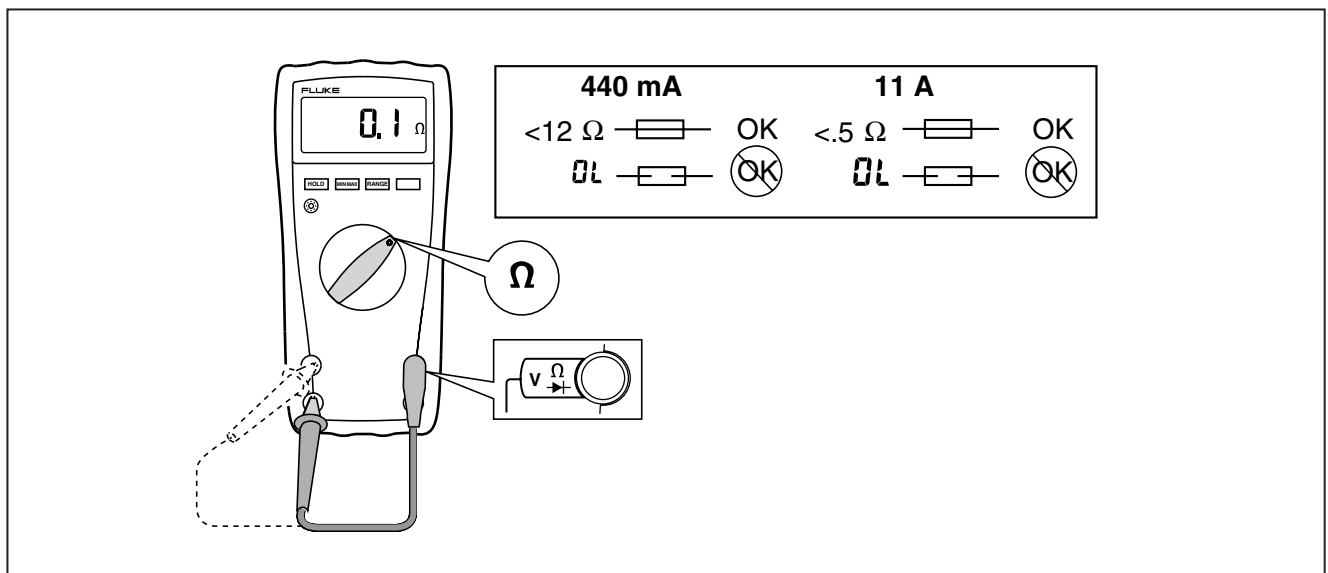

Figure 1. Testing the Current Fuses

aik12f.eps

Replacing the Fuses

⚠ ⚠ Warning

To avoid electrical shock, arc blast, or damage to the Meter, install only fuses with the amperage, interrupt, voltage, and speed ratings specified in Table 5.

To replace the Fuses (refer to Figure 2):

1. Turn the Rotary Switch to **OFF**.
2. Disconnect the test leads and/or any connectors from the terminals.
3. Remove the four screws from the Case Bottom and separate the Case Top from the Case Bottom.
4. Remove the fuses by gently prying one end loose, then slide the fuse out of its bracket, and replace with a properly rated good fuse.
5. Rejoin the Case Bottom and Case Top, and reinstall the four screws.

Replacing the Battery

⚠ ⚠ Warning

To avoid false readings, which could lead to possible electric shock or personal injury, replace the Battery as soon as the low battery indicator () appears.

To replace the Battery (refer to Figure 2):

1. Turn the Rotary Switch to **OFF** and remove the test leads from the terminals.
2. Remove the two screws from the Battery Compartment Door, and remove it from the Case Bottom.
3. Remove the Battery from the battery connector.
4. Replace the Battery with a new 9 V battery (NEDA A1604, 6F22, or 006P).
5. Reattach the Battery Compartment Door to the Case Bottom and reinstall the two screws.

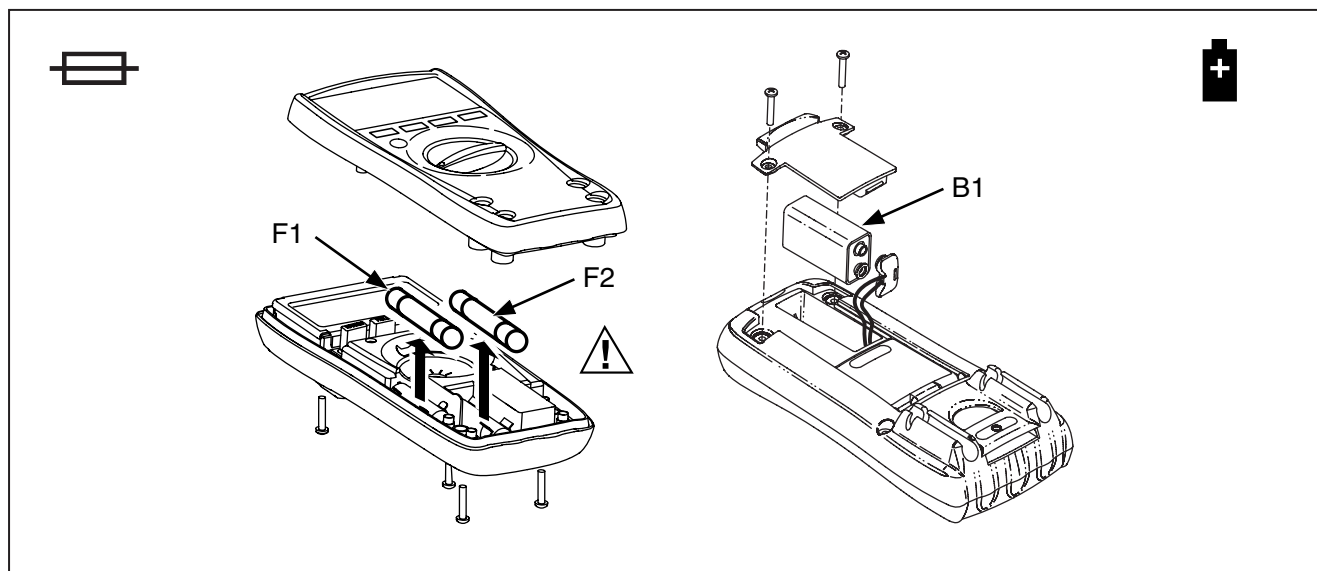

Figure 2. Battery and Fuse Replacement

aik13f.eps

Cleaning

⚠⚠ Warning

To avoid electrical shock:

- Remove test leads and any input signals before cleaning.
- Do not reinstall the pca until it is completely dry.

Dirt or moisture in the terminals can affect readings.

⚠ Caution

To avoid damaging the Meter, do not use aromatic hydrocarbons or chlorinated solvents for cleaning. These solutions will react with the plastics used in the instruments.

Do not use detergents of any kind for cleaning the pca.

Clean the instrument case with a damp cloth and mild detergent.

The pca may be washed with isopropyl alcohol or hot deionized water and a soft brush. Remove excess cleaning material with clean dry air at low pressure, then dry the pca at 50 °C.

Replacing the LCD

⚠ Caution

To prevent contamination, do not handle the conductive edges of the LCD or the LCD Elastomeric Connectors.

If the edges are contaminated, clean them with alcohol. Allow the alcohol to dry before reassembling.

To remove and replace the LCD, perform the following procedure (refer to Figure 3):

1. Turn the Rotary Switch to **OFF** and remove the test leads from the Meter terminals.
2. Remove the four screws from the Case Bottom, and separate the Case Top from the Case Bottom. The circuit board remains attached to the Case Bottom.
3. Remove battery compartment door and disconnect the battery from the battery connector.
4. Remove the PCA Screw located under the 440 mA Fuse, and lift the pca out of the Case Bottom. The beeper is loose in the bottom case. Exercise caution not to damage it.
5. Loosen the 4 screws on the back of the pca. This will facilitate reinstalling the LCD.
6. Insert a small, flat-head screwdriver under the LCD Mask edge and gently pry the LCD Mask from the snaps.

⚠ Caution

Take care to not break the LCD with the screwdriver.

7. Lift out the LCD.
8. Make sure that all connector contact points are clean. Refer to “Cleaning” for more information.
9. Install a new LCD, taking care that it is correctly oriented.
10. Reattach the LCD Mask to the LCD assembly by snapping the LCD Mask into place.
11. Tighten the 4 screws on the back of the pca.
12. Lay the pca back into the Case Bottom, and screw it down.
13. Reinsert the 440 mA Fuse.
14. Reinstall the Battery.
15. Rejoin the Case Bottom, Case Top, battery compartment door and reinstall the four case screws.

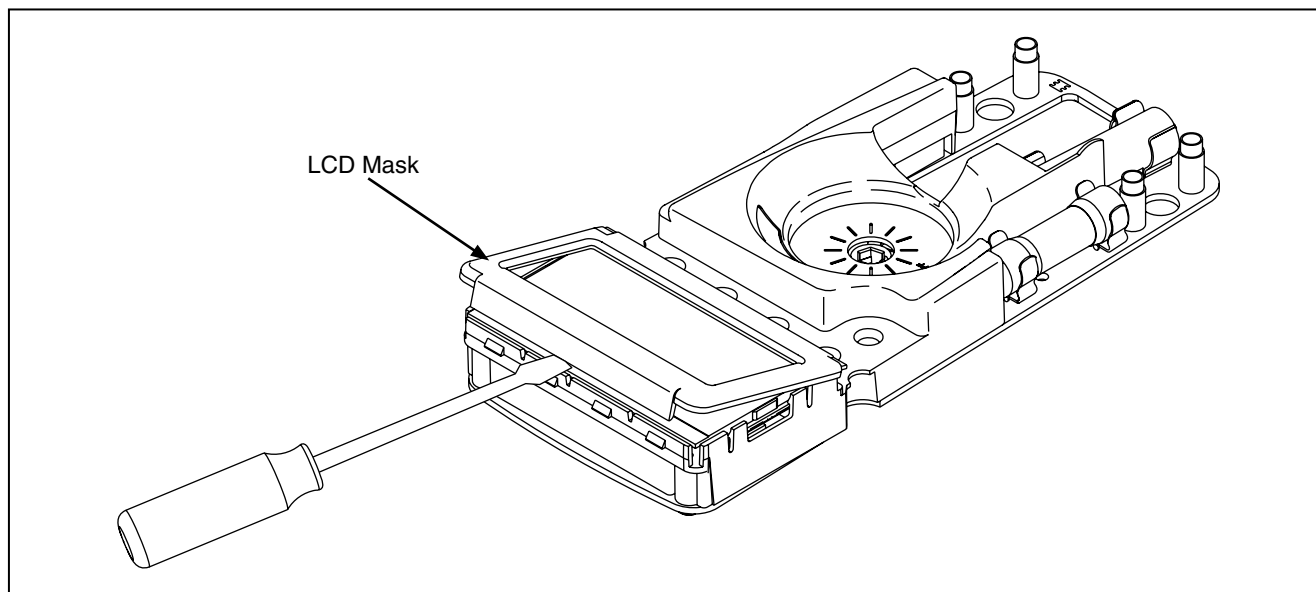

aik15f.eps

Figure 3. Removing the LCD Mask

Performance Tests

⚠ ⚠ Warning

To avoid electric shock, do not perform the performance test procedures unless the Meter is fully assembled.

The following performance tests verify the complete operation of the Meter and check the accuracy of each Meter function against its specifications. If the Meter fails any part of the test, calibration adjustment and/or repair is indicated.

In the performance tests, the Meter is referred to as the unit under test (UUT).

Required Equipment

A Fluke 5500A Multi-Product Calibrator (or equivalent) is required for the performance test procedures in this document.

If an equivalent calibrator is used, it must meet the accuracy specifications shown in Table 1.

Table 1. Calibrator Specifications

Recommended Equipment	Measurement Function	Accuracy
5500A Multi-Product Calibrator (or equivalent)	DC Volts	0 to 1000 V ± 0.0225 %
	DC Current	0 to 10 A ± 0.25 %
	AC Volts	0 to 1000 V ± 0.25 % @ 45 Hz to 1 kHz
	AC Current	0 to 10 A ± 0.375 % @ 45 Hz to 1 kHz
	Resistance	0 to 6 MΩ ± 0.225 %
		6 MΩ to 50 MΩ ± 0.5 %
	Capacitance	900 nF ± 0.30 %
	Temperature	0.25 %
Frequency	0.5 Hz to 100 kHz ± 0.025 %	
Fluke 80 AK Thermocouple Adapter Accessory	K-type	-
K-type Thermocouple	K-type, mini-plug on both ends	-

Preparing for the Performance Test

⚠⚠ Warning

To avoid possible electric shock or personal injury:

- **Do not perform the following procedures unless qualified to do so. Some procedures involve the use of high voltages.**
- **Before handling the test connections and in between tests, make sure the calibrator is in standby mode (STBY).**

To prepare for the performance test:

1. Make sure that you have the required equipment (refer to Table 1).
2. Warm up the calibrator as required by its specifications.
3. Allow the temperature of the UUT to stabilize at room temperature (23 °C ± 5 °C [73 °F ± 9 °F]).
4. Check the fuses and Battery, and replace them if necessary. Refer to "Testing the Fuses", "Replacing the Fuses", and "Replacing the Battery".

Performance Tests

Note

When calibrating or measuring AC current, avoid the potential for errors from coupled noise, by either:

1. Shorting the $V\Omega\rightarrow$ to the COM input
or
 2. Having NO connection to the $V\Omega\rightarrow$ input.
1. Set the UUT Rotary Switch to the position called for in Table 2 (175) or Table 3 (177/179), and for all measurements other than current (amps), connect the calibrator to the $V\Omega\rightarrow$ and COM input terminals.
 - If testing the milliamps function, connect the calibrator to the Meter **400 mA** and COM input terminals.
 - If testing the amps function, connect the calibrator to the Meter **10A** and COM input terminals.
 2. Referring to Table 2 or Table 3, apply the indicated calibrator output voltages to the UUT for each test.
 3. Verify that the UUT displays a reading that is within the limits shown in the Meter Response column.





Table 2. Performance Tests 175

Test (Switch Position)	5500 Output	Meter Response	
		Lower Limit	Upper Limit
\tilde{V} AC Volts	300 mV 45 Hz	296.7 mV ac	303.3 mV ac
	5 V 500 Hz	4.947 V ac	5.053 V ac
	5 V 1 kHz	4.897 V ac	5.103 V ac
	50 V 45 Hz	49.47 V ac	50.53 V ac
	50 V 1 kHz	48.97 V ac	51.03 V ac
	300 V 45 Hz	296.7 V ac	303.3 V ac
	500 V 500 Hz	494.7 V ac	505.3 V ac
	500 V 1 kHz	489.7 V ac	510.3 V ac
\tilde{V} Hz AC Volts Frequency ¹	1 V 45 Hz	44.94 Hz	45.06 Hz
	5 V 50 kHz	49.94 kHz	50.06 kHz

Table 2. Performance Tests 175 (continued)

Test (Switch Position)	5500 Output	Meter Response	
		Lower Limit	Upper Limit
$\overline{\text{V}}$ DC Volts	5 V	4.990 V dc	5.010 V dc
	300 V	299.3 V dc	300.7 V dc
	1000 V	996 V dc	1004 V dc
	-1000 V	-1004 V dc	-996 V dc
$\overline{\text{V}}$ Hz DC Volts Frequency ¹	3 V 45 Hz	44.94 Hz	45.06 Hz
	30 V 50 kHz	49.94 kHz	50.06 kHz
$\overline{\text{mV}}$ DC Millivolts	30 mV 0 Hz	29.8 mV dc	30.2 mV dc
	-300 mV	-300.7 mV dc	-299.3 mV dc
	600 mV	598.9 mV dc	601.1 mV dc
Ω Ohms ²	19 Ω	18.6 Ω	19.4 Ω
	19 M Ω	18.68 M Ω	19.32 M Ω
$\overline{\text{C}}$ Capacitance ¹	Apply 0.90 μF	887 nF	913 nF
$\overline{\text{ }}$ Continuity	25 Ω	Beeper On	
	250 Ω	Beeper Off	
$\overrightarrow{\text{D}}$ Diode ¹	Apply 2.0 V	1.978 V dc	2.022 V dc
$\overline{\text{mA}}$ AC Milliamps	3 mA 45 Hz	2.92 mA ac	3.08 mA ac
	50 mA 1 kHz	49.22 mA ac	50.78 mA ac
	400 mA 1 kHz	393.7 mA ac	406.3 mA ac
$\overline{\text{A}}$ AC Amps	4.0 A 45 Hz	3.937 A ac	4.063 A ac
	9.0 A 1 kHz	8.83 A ac	9.17 A ac
$\overline{\text{mA}}$ DC Milliamp ¹	3 mA, 0 Hz	2.94 mA dc	3.06 mA dc
	50 mA	49.47 mA dc	50.53 mA dc
	-400 mA	-404.3 mA dc	-395.7 mA dc
$\overline{\text{A}}$ DC Amps ¹	4.0 A	3.957 A dc	4.043 A dc
	-9.0 A	-9.12 A dc	-8.88 A dc
<ol style="list-style-type: none"> 1. Press the YELLOW button to access this function. 2. Does not include test lead resistance. 			

Table 3. Performance Tests 177/179

Test	5500 Output	Meter Response	
		Lower Limit	Upper Limit
\tilde{V} AC Volts	300 mV 45 Hz	296.7 mV ac	303.3 mV ac
	5 V 500 Hz	4.947 V ac	5.053 V ac
	5 V 1 kHz	4.897 V ac	5.103 V ac
	50 V 45 Hz	49.47 V ac	50.53 V ac
	50 V 1 kHz	48.97 V ac	51.03 V ac
	300 V 45 Hz	296.7 V ac	303.3 V ac
	500 V 500 Hz	494.7 V ac	505.3 V ac
	500 V 1 kHz	489.7 V ac	510.3 V ac
\tilde{V} Hz AC Volts Frequency ¹	1 V 45 Hz	44.94 Hz	45.06 Hz
	5 V 50 kHz	49.94 kHz	50.06 kHz
\bar{V} DC Volts	5 V	4.993 V dc	5.007 V dc
	300 V	299.5 V dc	300.5 V dc
	1000 V	997 V dc	1003 V dc
	-1000 V	-1003 V dc	-997 V dc
\bar{V} Hz DC Volts Frequency ¹	3 V 45 kHz	44.94 Hz	45.06 Hz
	30 V 50 kHz	49.94 kHz	50.06 kHz
\bar{mV} DC Millivolts	30 mV 0 Hz	29.8 mV dc	30.2 mV dc
	-300 mV	-300.5 mV dc	-299.5 mV dc
	600 mV	599.3 mV dc	600.7 mV dc
 Temperature ^{1,3,4} (179 only)	0 °C	-1.0 °C	1.0 °C
	-40 °C	-41.4 °C	-38.6 °C
	400 °C	395.0 °C	405.0 °C
Ω Ohms ²	19 Ω	18.6 Ω	19.4 Ω
	19 M Ω	18.68 M Ω	19.32 M Ω
 Capacitance ¹	0.90 μ F	887 nF	913 nF
 Continuity	25 Ω	Beeper On	
	250 Ω	Beeper Off	
 Diode ¹	2.0 V	1.978 V dc	2.022 V dc

1. Press the YELLOW button to select this function.
2. Does not include test lead resistance.
3. Be sure to use correct cable.
4. To ensure accuracy, the Meter and thermocouple adapter must be at the same temperature. Allow 20 minutes before performing the temperature procedures.

Table 3. Performance Tests 177/179 (continued)

Test	5500 Output	Meter Response	
		Lower Limit	Upper Limit
$\tilde{\text{mA}}$ AC Milliamps	3 mA 45 Hz	2.92 mA ac	3.08 mA ac
	50 mA 1 kHz	49.22 mA ac	50.78 mA ac
	400 mA 1 kHz	393.7 mA ac	406.3 mA ac
$\tilde{\text{A}}$ AC Amps	4.0 A 45 Hz	3.937 A ac	4.063 A ac
	9.0 A 1 kHz	8.83 A ac	9.17 A ac
$\overline{\text{mA}}$ DC Milliamps ¹	3 mA, 0 Hz	2.94 mA dc	3.06 mA dc
	50 mA	49.47 mA dc	50.53 mA dc
	-400 mA	-404.3 mA dc	-395.7 mA dc
$\overline{\text{A}}$ DC Amps ¹	4.0 A	3.957 A dc	4.043 A dc
	-9.0 A	-9.12 A dc	-8.88 A dc

1. Press the YELLOW button to select this function.
2. Does not include test lead resistance.
3. Be sure to use correct cable.
4. To ensure accuracy, the Meter and thermocouple adapter must be at the same temperature. Allow 20 minutes before performing the temperature procedures.

Calibration Adjustment

Perform the calibration adjustment procedures if the Meter fails the performance test.

The Meter buttons behave as follows when the calibration mode is enabled:

- Press and hold this button to test the present function. This measurement is uncalibrated and may be inaccurate. This is normal.
- Press and hold this button to display the required input.
- Press this button to skip the present calibration step without accepting the input signal.

Note

If a calibration step is skipped, the remaining calibration procedure may be invalidated.

Note

This feature is not available for units with serial numbers between 83911001 – 83911240 and 84060001 and above.

- Press this YELLOW button to store the calibration value and advance to the next step. This button is also used to exit calibration mode after the calibration adjustment sequence is complete.

Calibration Adjustment Procedure

Use the following steps to adjust the Meter's calibration:

For Meters with a serial number of 84060000 and below, switch the Meter to volts **AC** ($\tilde{\text{V}}$). For Meters with a serial number of 83911001 – 83911240 and 84060001 and above, switch the Meter to **mV DC**.

1. Turn the Meter over and find the Calibration Seal located near the top of the Meter (refer to Figure 4).

2. With a small probe, break the Calibration Seal and press the Calibration Button for 1 second. The Meter will beep and change to the calibration mode. The display reads $\text{[} \cdot \text{]}$, designating the first calibration step. The Meter remains in calibration mode until the Rotary Function Switch is turned off.
3. Proceed through the calibration steps by entering the input value listed in the table for each step.

Note

When calibrating or measuring AC current, avoid the potential for errors from coupled noise, by either:

1. *Shorting the $\text{V}\Omega\text{--}\rightarrow$ to the COM input*
or
2. *Having NO connection to the $\text{V}\Omega\text{--}\rightarrow$ input.*

Note

After pressing the YELLOW button, wait until the step number advances before changing the calibrator source or turning the Rotary Function Knob.

4. After each input value is applied, press the YELLOW button to accept the value and proceed to the next step ($\text{[} \cdot \text{]}$ and so forth).
5. When the last step in a function is reached, turn the Rotary Function Knob to the next required function. The Meter will not allow a step to be completed if the Rotary Function Knob is turned to the wrong function.

Note

If the calibration adjustment procedure is not completed correctly, the Meter will not operate correctly. When calibration adjustment is not performed correctly, the Meter displays the messages "CAL" and "Err" and the Meter must be recalibrated.

The Meter is damaged and requires service if:

- *"CAL" and "Err" messages continue to appear after a proper recalibration.*
- *"EEPr" and "Err" messages are alternating on the display.*
- *"EEPr" message appears on the display.*

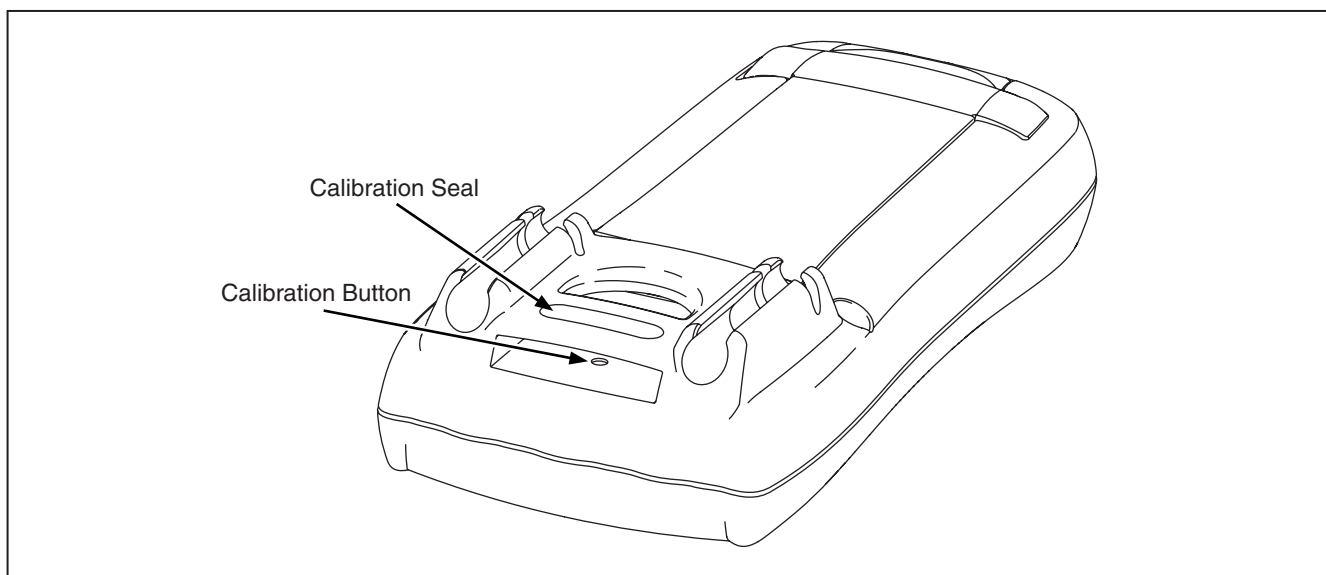

Figure 4. Calibration Access

aik14f.eps

Table 4. Calibration Steps

If the Meter has a serial number of 84060000 or below, use the following steps.		
Function (Switch Position)	Calibration Step	Input Value
\tilde{V} (AC Volts)	C-01	6.000 V, 900.0 Hz
	C-02	600.0 mV, 100 Hz
	C-03	6.000 V, 100 Hz
\bar{V} (DC Volts)	C-04	6.000 V dc
	C-05	60.00 V dc
	C-06	600.0 V dc
	C-07	1000 V dc
\bar{mV} DC Millivolts (temperature - 179 only)*	C-08	600.0 mV dc
	C-09	0.0 °C
Ω (Ohms)	C-09 (175/177)	6.000 k Ω
	C-10 (179)	
 (Continuity)	C-10 (175/177)	600 Ω
	C-11 (179)	
mA (Milliamps)	C-11 (175/177)	600.0 mA dc
	C-12 (179)	
A (Amps)	C-12 (175/177)	6.000 A dc
	C-13 (179)	
* To ensure accuracy, the Meter and Thermocouple Adapter must be at the same temperature. Allow 20 minutes before performing the temperature procedures.		

Table 4. Calibration Steps (continued)

If the Meter has a serial number between 83911001 – 83911240 or 84060001 and above, or if the model number flashes on the display at turn on, use the following steps.*		
Function (Switch Position)	Calibration Step	Input Value
$\overline{\text{mV}}$ (DC Millivolts)	C-01	600.0 mV dc
	C-02	120.0 mV dc
$\overline{\text{V}}$ (DC Volts)	C-03	6.000 V dc
	C-04	60.00 V dc
	C-05	600.0 V dc
$\widetilde{\text{V}}$ (AC Volts)	C-06	600.0 mV, 60 Hz
	C-07	600.0 V, 60 Hz
Ω (Ohms)	C-08	600.0 Ω
	C-09	6.000 k Ω
	C-10	60.00 k Ω
	C-11	600.0 k Ω
	C-12	6.000 M Ω
$\rightarrow +$ (Diode Test)	C-13	5.000 V dc
mA (Milliamps)	C-14	400.0 mA dc
	C-15	400.0 mA ac, 60 Hz
A (Amps)	C-16	6.000 A dc
	C-17	6.000 A ac, 60 Hz

* If the Meter is not connected correctly, or if the rotary switch is in the wrong position, the Meter will beep 2 times to alert the user.

User-Replaceable Parts and Accessories

User-replaceable parts and accessories are shown in Table 5 and Figure 5.

Table 5. User-Replaceable Parts and Accessories

Item	Description	Part No	Qty
--	(Not shown) TL75 Test Lead Set**	855705	1
--	(Not Shown) 179, 177, 175 Users Manual (Americas)	1564823	1
	179, 177, 175 Users Manual (North Europe)	1580498	1
	179, 177, 175 Users Manual (Southern Europe)	1580480	1
	179, 177, 175 Users Manual (Asia)	1580500	1
--	Calibration Information (Not Shown)	1600476	1
1	Case Top (Model 175)	1591675	1
	Case Top (Model 177)	1589129	1
	Case Top (Model 179)	1589118	1
2	Window	648714	1
3	Shock Absorber	428441	1
4	Keypad (177, 179)	1560052	1
	Keypad (175)	1560842	1
5	LCD Mask (175)	1587908	1
	LCD Mask (177)	1587896	1
	LCD Mask (179)	1587881	1
6	LCD	1560856	1
7	LCD Light Pipe (177 & 179)	1564806	1
9	⚠ Fuse, 440 mA (fast acting), 1000 V ac/dc , minimum interrupt rating 10 kA *	943121	1
8	⚠ Fuse, 11 A, (fast acting), 1000 V ac/dc, minimum interrupt rating 17 kA *	803293	1
10	PCA Screw	519116	1
11	Shield, AC	648755	1
12	AC Shield and Internal Cover screws	448456	5
13	Case Bottom (serial number 84060000 and below)	1564773	1
13	Case Bottom (serial number 84060001 and above or serial numbers between 83911001 - 83911240)	2042927	1
14	Battery, 9 V (Alkaline, 9 V, 0-200 mA)	614487	1
15	Battery Compartment Door	1564799	1
16	Case Screws	832246	4
17	Tilt Stand	648961	1
18	LCD Elastomeric Connector	650264	2
19	Internal Cover	1564786	1
<p>* ⚠ To avoid shock, injury, or damage to the meter, use exact replacement only.</p> <p>** Fluke accessories are available from your authorized Fluke distributor.</p>			

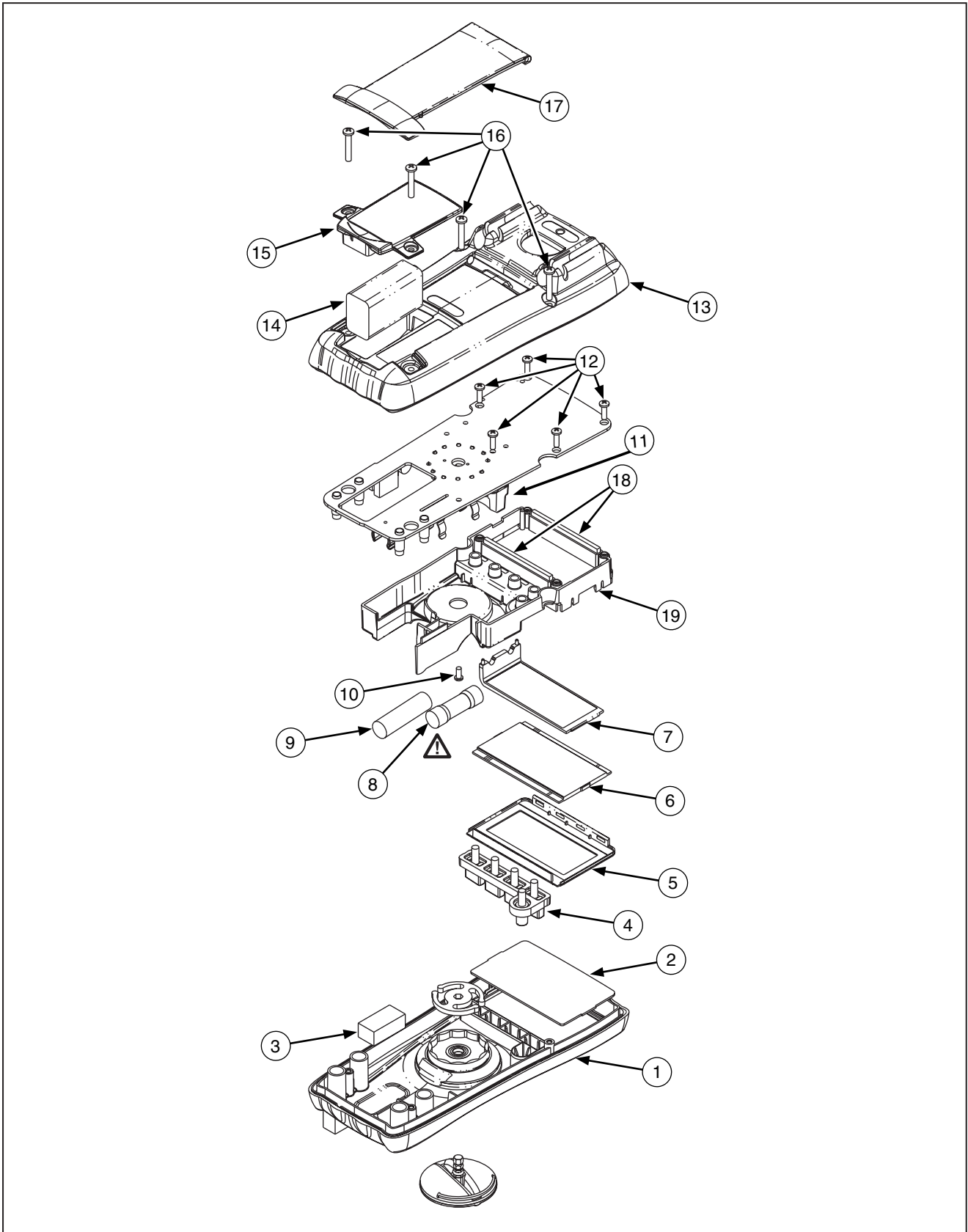

Figure 5. User-Replaceable Parts and Accessories

aik16f.eps

Lifetime Limited Warranty

Each Fluke 20, 70, 80, 170 and 180 Series DMM will be free from defects in material and workmanship for its lifetime. As used herein, "lifetime" is defined as seven years after Fluke discontinues manufacturing the product, but the warranty period shall be at least ten years from the date of purchase. This warranty does not cover fuses, disposable batteries, damage from neglect, misuse, contamination, alteration, accident or abnormal conditions of operation or handling, including failures caused by use outside of the product's specifications, or normal wear and tear of mechanical components. This warranty covers the original purchaser only and is not transferable.

For ten years from the date of purchase, this warranty also covers the LCD. Thereafter, for the lifetime of the DMM, Fluke will replace the LCD for a fee based on then current component acquisition costs.

To establish original ownership and prove date of purchase, please complete and return the registration card accompanying the product, or register your product on <http://www.fluke.com>. Fluke will, at its option, repair at no charge, replace or refund the purchase price of a defective product purchased through a Fluke authorized sales outlet and at the applicable international price. Fluke reserves the right to charge for importation costs of repair/replacement parts if the product purchased in one country is sent for repair elsewhere.

If the product is defective, contact your nearest Fluke authorized service center to obtain return authorization information, then send the product to that service center, with a description of the difficulty, postage and insurance prepaid (FOB Destination). Fluke assumes no risk for damage in transit. Fluke will pay return transportation for product repaired or replaced in-warranty. Before making any non-warranty repair, Fluke will estimate cost and obtain authorization, then invoice you for repair and return transportation.

THIS WARRANTY IS YOUR ONLY REMEDY. NO OTHER WARRANTIES, SUCH AS FITNESS FOR A PARTICULAR PURPOSE, ARE EXPRESSED OR IMPLIED. FLUKE SHALL NOT BE LIABLE FOR ANY SPECIAL, INDIRECT, INCIDENTAL OR CONSEQUENTIAL DAMAGES OR LOSSES, INCLUDING LOSS OF DATA, ARISING FROM ANY CAUSE OR THEORY. AUTHORIZED RESELLERS ARE NOT AUTHORIZED TO EXTEND ANY DIFFERENT WARRANTY ON FLUKE'S BEHALF. Since some states do not allow the exclusion or limitation of an implied warranty or of incidental or consequential damages, this limitation of liability may not apply to you. If any provision of this warranty is held invalid or unenforceable by a court or other decision-maker of competent jurisdiction, such holding will not affect the validity or enforceability of any other provision.

Fluke Corporation
P.O. Box 9090
Everett, WA 98206-9090
U.S.A.

Fluke Europe B.V.
P.O. Box 1186
5602 BD Eindhoven
The Netherlands

