

FLUKE®

78

Automotive Meter

Users Manual

For IEC 61010 CAT II Meters Only

PN 666625



November 1998 Rev.1, 9/00

© 1998, 2000 Fluke Corporation. All rights reserved. Printed in U.S.A.

All product names are trademarks of their respective companies.

Table of Contents

Title	Page
What is in the Manual.....	1
Using the Meter Safely.....	1
Getting Acquainted with the Meter.....	4
Rotary Switch.....	4
Input Jacks.....	6
Thermocouple Adapter.....	6
Display.....	8
○ Pushbutton.....	10
Standby (Sleep) Mode.....	10
Bar Graph.....	12
Autorange with "Floor".....	12
Typical Testing Applications.....	14
\hat{V}, \bar{V} How to Measure Voltage.....	14
$\rightarrow +$ How to Test Diodes.....	16
$\bar{A}, A \sim$ How to Measure Current.....	18
$\square $ How to Test Continuity.....	20
Ω How to Measure Resistance.....	22
RPM \textcircled{R} How to Measure RPM with the RPM80 Inductive Pickup (Optional).....	24

Hz  How to Use DC-Coupled HZ to Check BP/MAP Sensors	26
Hz  How to Use AC-Coupled Hz on a Crankshaft Position Sensor	28
 % How to Measure Dwell on Conventional Ignitions	30
% How to Measure Duty Cycle on a Feedback Carburetor	32
°C °F How to Measure Temperature on a Coolant Temperature Sensor	34
How to Store Minimum and Maximum Measurements	36
How to Use the Bar Graph to Test a Throttle Position Sensor	38
How to Lock the Meter in a Measurement Range	40
Using the Holster and Flex-Stand	40
Maintenance	42
Cleaning	42
Calibration	42
How to Test the Fuse	42
How to Replace the Battery or Fuse	42
Accessories and Parts	42
Specifications	46

List of Tables

Table	Title	Page
1.	Symbols	1
2.	Measurement Unit Symbols	8
3.	Pushbutton Operations	11
4.	Replacement Parts and Accessories	45

List of Figures

Figure	Title	Page
1.	Rotary Switch	5
2.	Input Jacks	7
3.	Display	9
4.	Interpreting the Bar Graph	13
5.	Measuring No-Load Voltage of Battery	15
6.	Testing Diodes in Alternator Rectifier Bridge	17
7.	Isolating Circuit Causing Current Drain	19
8.	Testing Continuity in a Switch	21
9.	Measuring Resistance to Check Coolant Temperature Sensor	23
10.	Measuring RPM with the (Optional) Inductive Pickup	25
11.	Checking Barometric Pressure/Manifold Absolute Pressure Sensor	27
12.	Using AC Coupled-Frequency on a Crankshaft Position Sensor	29
13.	Measuring Dwell on a Conventional Ignitions	31
14.	Measuring Duty Cycle on a Feedback Carburetor	33
15.	Measuring the Temperature of Coolant Temperature Sensor.....	35
16.	Using MIN MAX to Check an Oxygen Sensor.....	37
17.	Using Bar Graph to Observe Sweep of Throttle Position Sensor (TPS)	39

18.	Holster and Flex-Stand	41
19.	Fuse Test.....	43
20.	Fuse and Battery Replacement	44
21.	Replacement Parts	45

APPLICATIONS GUIDE

	Amps DC*	Bar Graph	Continuity →	% Duty Cycle	Dwell	Hz	Millivolts	MIN MAX	Ohms	RPM**	Temperature	Volts AC	Volts DC
IGNITION/ENGINE													
Coils										•			•
Computer Temp Sensors								•	•		•		•
Condensers (Capacitors)	•								•				•
Connectors			•				•	•	•				•
Contacts Set	•	•		•	•		•						•
Distributor Cap									•				
Engine Speed										•			
Feedback Carburetors				•	•	•			•			•	•
Fuel Injectors (Electronic)	•			•	•				•				•
Hall-Type Sensors	•					•	•		•	•		•	•
Idle Air Motors	•			•	•		•	•					
Ignition Modules	•						•		•				•
MAF Sensor						•	•					•	
Magnetic Pickups	•	•				•	•		•	•		•	•
MAP & BP Sensors	•					•	•						•
O ₂ Sensors	•					•	•	•					
Throttle Position Sensors	•								•	•			•
STARTING SYSTEM													
Battery	•								•			•	•
Connectors							•		•				•
Interlocks (neutral safety switch)				•				•	•				•
Solenoids				•			•	•	•				•
Starters	•						•	•		•			•

* Used with Fluke 80i-410 or 80i-1010 current clamp.

** With optional RPM 80 Inductive Pickup accessory.

APPLICATIONS GUIDE (cont)

	Amps DC*	Bar Graph	Continuity	% Duty Cycle	Dwell	Hz	Millivolts	MIN MAX	Ohms	RPM **	Temperature	Volts AC	Volts DC
COOLING SYSTEM													
Connectors			•				•	•	•				•
Fan Motor			•						•				•
Radiator								•			•		
Relays							•	•	•				•
Temperature Sensors								•	•		•		
Temperature Switches									•	•	•	•	•
CHARGING SYSTEM													
Alternators	•			•				•	•			•	•
Computerized Regulators	•			•		•		•					•
Connectors			•					•	•	•			
Diodes, (AC Ripple)								•	•			•	
Diode Rectifier			•	•									•
Regulators	•	•						•	•				•
BODY ELECTRIC													
Compressor Clutch			•				•	•					•
Lighting Circuits			•						•				•
Relay and Motor Diodes			•										
Transmissions			•					•	•				

* Used with Fluke 80i-410 or 80i-1010 current clamp.

** With optional RPM 80 Inductive Pickup accessory.

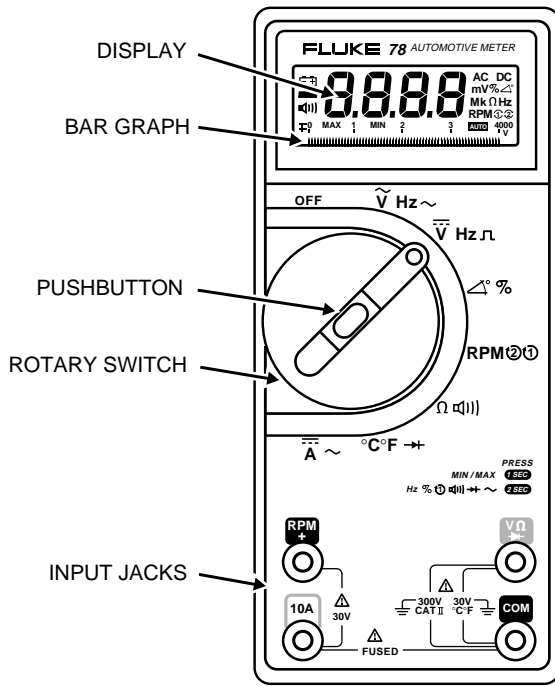

FRONT

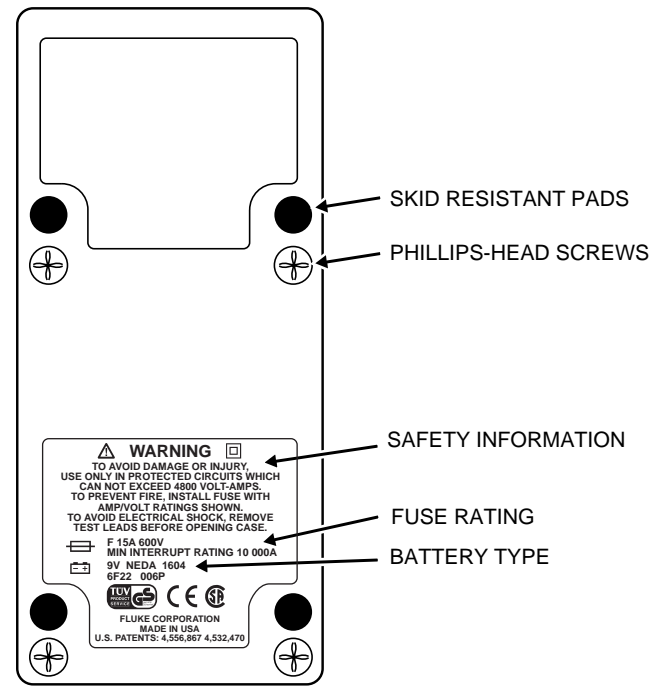

BACK

Warning

Read "Using the Meter Safely" before using the meter.

Note

The automotive tests included in this manual are intended to help you learn how to use the meter. Consult your car's service manual for specific procedures that apply to your car.

What is in the Manual

This manual provides safety information, operating instructions, basic maintenance procedures, and specifications for the Fluke 78 Automotive Meter (referred to as "the meter").

To contact Fluke, call one of the following telephone numbers:

USA: 1-888-99-FLUKE (1-888-993-5853)

Canada: 1-800-36-FLUKE (1-800-363-5853)

Europe: +31 402-678-200

Japan: +81-3-3434-0181

Singapore: +65-738-5655

Anywhere in the world: +1-425-446-5500

Or, visit Fluke's Web site at www.fluke.com

Refer to the 78 Service Manual (P/N 666617) for complete servicing information. If the meter is damaged or something is missing, contact the place of purchase immediately.









Fluke Corporation P.O. Box 9090 Everett WA 98206-9090

Fluke Europe B.V. P.O. Box 1186 5602 B.D. Eindhoven, The Netherlands

Using the Meter Safely

Use the meter as described in this manual. Otherwise the safety features provided by the meter might be impaired. A **Warning** identifies conditions and actions that pose hazards to the user; a **Caution** identifies conditions and actions that might damage the meter. International electrical symbols used on the meter are shown in Table 1.

Table 1. Symbols

Symbol	Meaning
	Important information. See manual.
	Alternating current (AC)
	Direct current (DC)
	Alternating or direct current (AC or DC)
	Diode
	Ground
	Fuse
	Double insulation (Protection Class II)
	Conforms to European Union directives

Read First: Safety Information

This meter complies with EN 61010-1:1993, ANSI/ISA S82.01-1994 and CAN/CSA C22.2 No. 1010.1-92 Overvoltage Category II. Use the meter only as specified in this Users Manual, otherwise the protection provided by the meter may be impaired.

Warning

To avoid possible electric shock or personal injury:

- Avoid working alone.
- Do not use the meter if it is damaged. Before use, inspect the case for cracks or missing plastic. Pay particular attention to the insulation surrounding the connectors.
- Inspect the test leads for damaged insulation or exposed metal. Check test lead continuity. Replace damaged leads.
- Do not use the meter if it operates abnormally. Protection may be impaired. When in doubt, have the meter serviced.
- Do not operate the meter around explosive gas, vapor or dust.
- Do not apply more than the rated voltage, as marked on the meter, between terminals or between any terminal and earth ground.
- Before each use, verify the meter's operation by measuring a known voltage.
- When servicing the meter, use only specified replacement parts.
- Use caution when working above 30 V ac rms, 42 V ac peak, or 60 V dc. Such voltages pose a shock hazard.
- Keep your fingers behind the finger guards on the probe when making measurements.
- Connect the common test lead before connecting the live test lead. Disconnect the live test lead first.
- Remove test leads from the meter before opening the case.

- Use only a single 9 V battery, properly installed in the meter case, to power the meter.
- Follow all equipment safety procedures.
- Before measuring current, check the meter's fuses (see "How to Test the Fuse").
- Never touch the probe to a voltage source when the test leads are plugged into the 10 A input jack.
- Always use clamp-on probes (dc current clamps) when measuring current exceeding 10 A.
- DO NOT connect thermocouple to voltages exceeding 30 V.

- To avoid false readings, which could lead to possible electric shock or personal injury, replace the meter's battery as soon as the low battery indicator () appears.

Caution

To avoid possible damage to the meter or to equipment under test:

- Disconnect the power to the circuit under test and discharge all high voltage capacitors before testing resistance, continuity or diodes.
- Use the proper function and range for your measurement applications.
- When measuring current, turn off circuit power before connecting the meter in the circuit. Remember to place the meter in series with the current.

Getting Acquainted with the Meter

Rotary Switch

Turn the rotary switch (Figure 1) from OFF to another switch setting to turn the meter ON. The display lights for 1 second as part of a selftest routine. The meter is now ready to take measurements.

Each switch setting has a primary AND an alternate function. Primary functions are in white; alternate functions are in yellow.

To toggle between a primary and alternate function, hold down the push-button for 2 seconds.

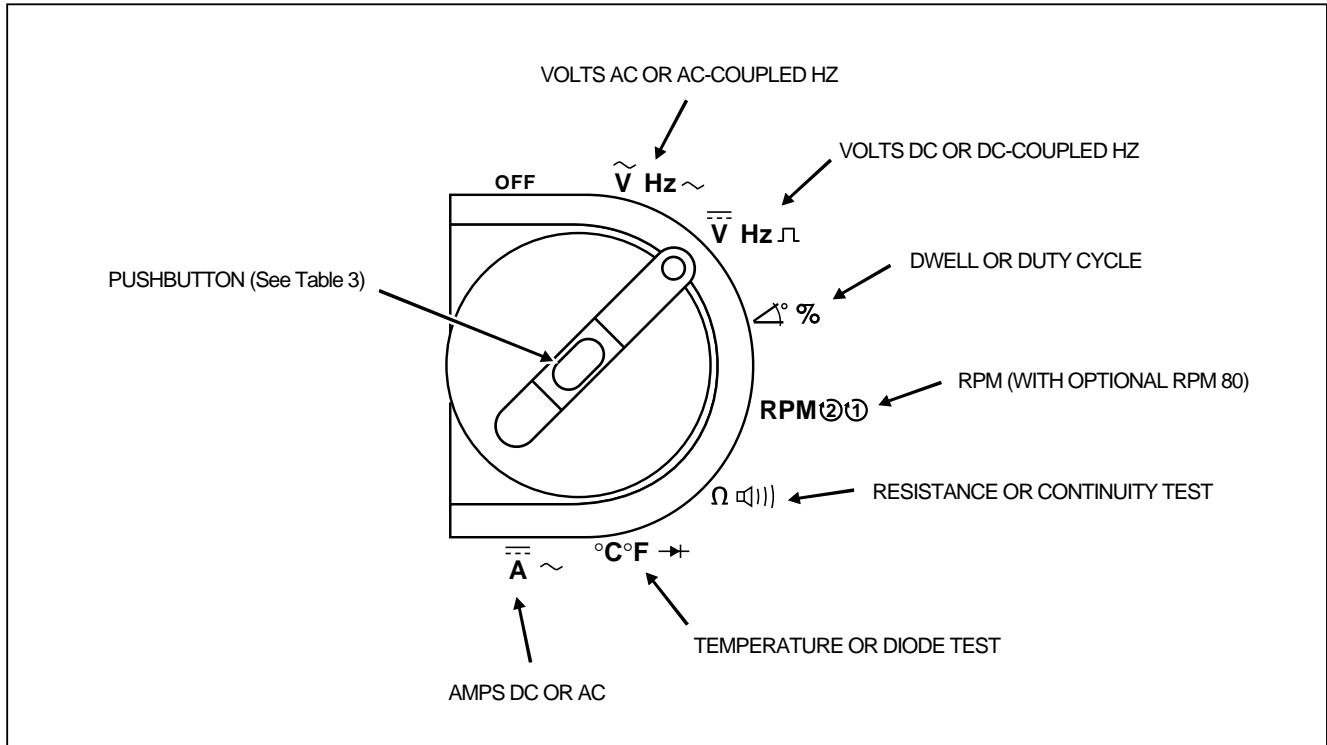

Figure 1. Rotary Switch

mt01f.eps

Input Jacks

Warning

To avoid personal injury or equipment damage, never attempt a voltage measurement if a test lead is in the 10A jack.

The meter has four input jacks (Figure 2) that are protected against overloads to the limits shown on the front and back of the meter.

Thermocouple Adapter

Warning

To avoid possible electric shock or personal injury, do not connect the thermocouple to voltages exceeding 30 V.

The 80BK Thermocouple Adapter allows you to use a thermocouple to measure temperature. If the adapter gets lost or damaged, replace the adapter with a Fluke-specified part (see Table 4) to ensure optimum performance of the thermocouple.

The meter measures temperature using Type-K thermocouple probes. This thermocouple is suitable for making surface temperature measurements from -40°C (or °F) to 260°C (500°F) in teflon-compatible environments.

Warning

To avoid personal injury or equipment damage, do not use this thermocouple in liquids or at temperatures above 260°C (500°F). At these temperatures the teflon insulation can emit toxic gases.

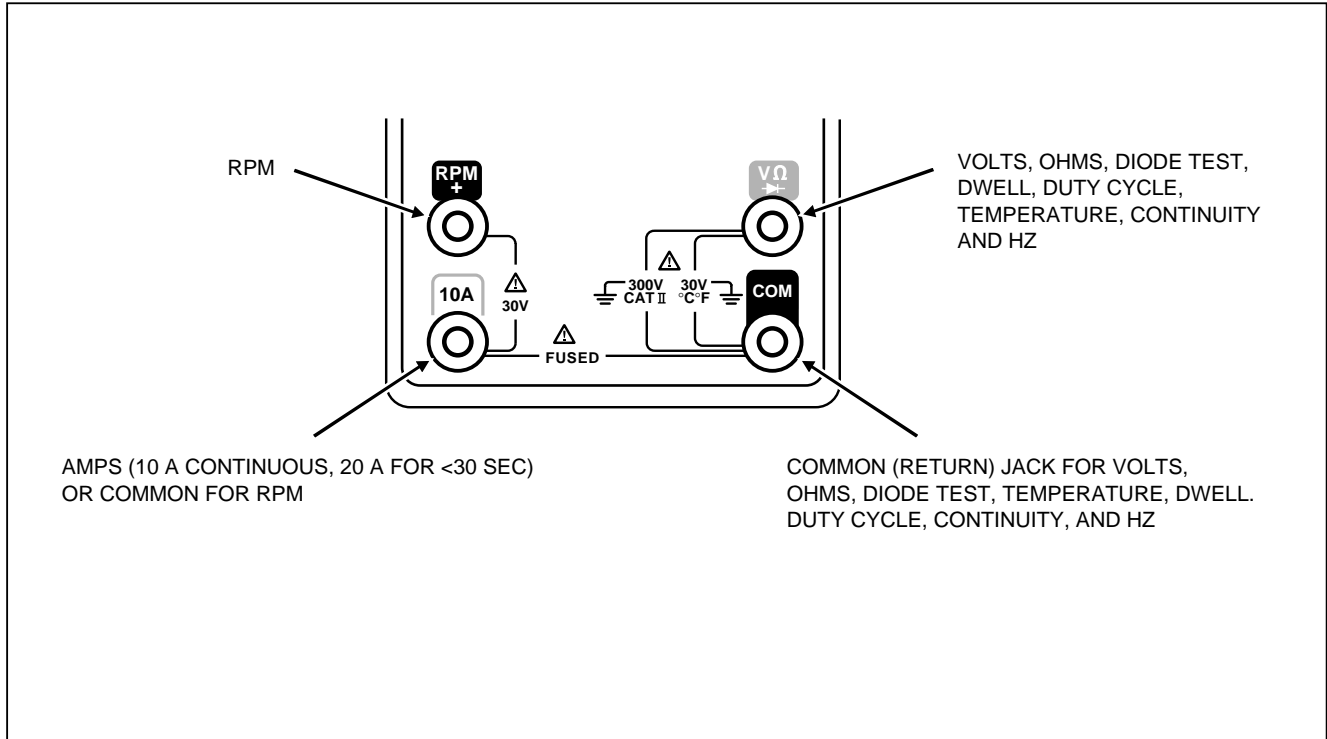

Figure 2. Input Jacks

mt02f.eps

Display

Readings are shown on a liquid crystal display (LCD). Symbols on the display indicate what the meter is doing. See Figure 3 and Table 2.

If a measurement is too large to be displayed, OL (overload) is shown on the display and the whole bar graph lights.

Warning

To avoid false readings, which could lead to possible electric shock or personal injury, replace the battery as soon as the battery indicator () appears.

Table 2. Measurement Unit Symbols

Symbol	Meaning
AC	Alternating current or voltage
DC	Direct current or voltage
V	Volts
Hz	Hertz (cycles/second). Frequency
RPM1	Revolutions/minute. 1 RPM count/spark
RPM2	Revolutions/minute. 2 RPM counts/spark
°C	Degrees Celsius
°F	Degrees Fahrenheit
-Cyl	Number of Cylinder
%	Percent (for duty cycle readings)
°	Degrees of rotation (for dwell readings)
Ω	Ohms. Resistance
k	Kilo. Units x 1,000
M	Mega. Units x 1,000,000
m	Milli. Units x 1/1,000

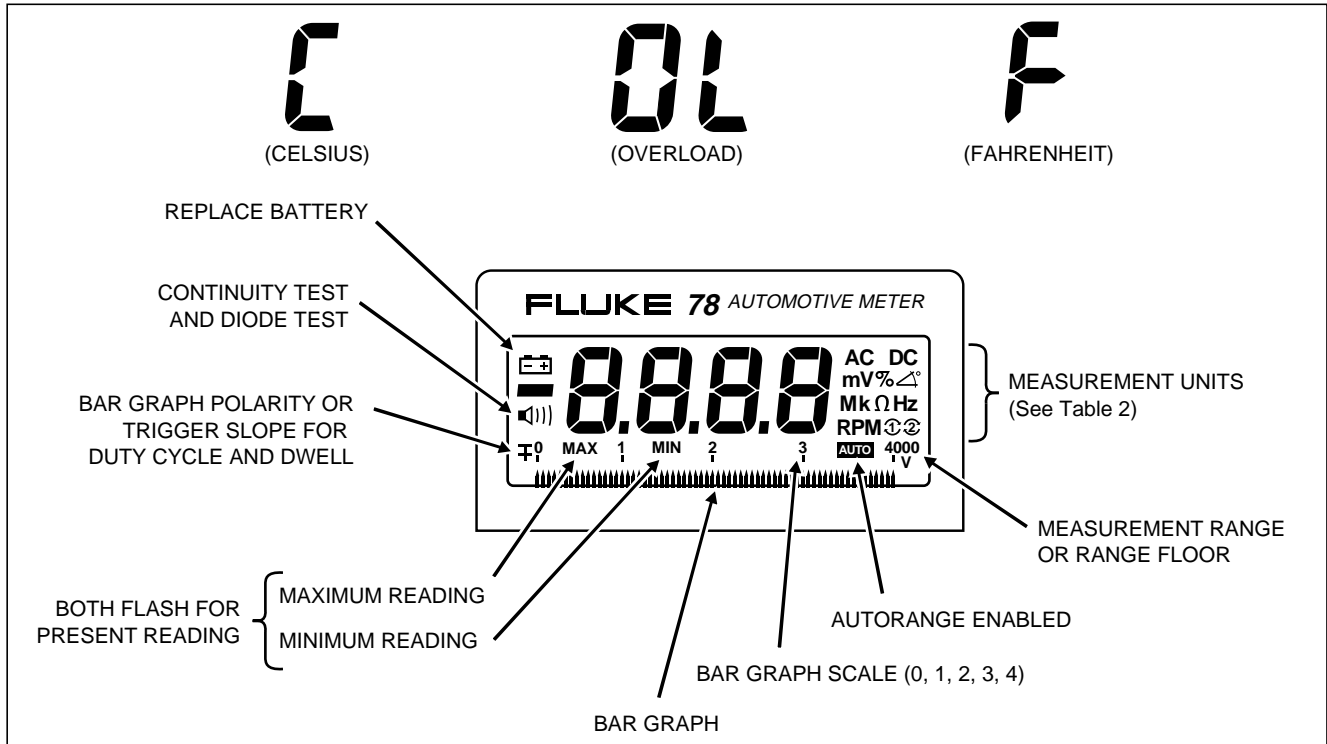



Figure 3. Display

mt03f.eps

Pushbutton

The pushbutton selects different operations, depending on the position of the rotary switch AND how long you hold it down. See Table 3:

- Press  for less than 1 second (a "momentary" press) to perform stepping or toggling operations (e.g., stepping through ranges or toggling between °C and °F).

The meter acknowledges a momentary press by a click.

- Press  for more than 1 but less than 2 seconds to enter the MIN MAX mode. In MIN MAX, the lowest and highest readings are stored. (See "How to Use MIN MAX")

The meter acknowledges a 1-second press by a click and a beep. The display briefly shows, "MAX", "MIN", and "▯▯▯▯".

- Press  for 2 seconds or longer to toggle between the primary and alternate function of a switch setting. (Primary functions are labeled white, secondary functions yellow.)

The meter acknowledges a 2 second press by a click, a single beep, and a double beep. The display briefly shows "- - - -".

Pushbutton operations are summarized in Table 3.

Standby (Sleep) Mode

If the meter is ON but the rotary switch or the pushbutton is not operated for 30 minutes, the meter enters the standby mode and the display goes blank. This extends battery life.

To resume operation, turn the rotary switch or press .

Standby is disabled in the MIN MAX mode.

Table 3. Pushbutton Operations

Switch Position	Momentary Press (<1 sec)	Press and Hold for 1 sec	Press and Hold for 2 sec
\tilde{V} Hz \sim	Manually changes range. In MIN MAX, press to display maximum, minimum, or present readings.	Toggles in and out of MIN MAX mode.	Toggles between volts AC and AC-coupled frequency.
\bar{V} Hz \square	Manually changes range. In MIN MAX, press to display maximum, minimum, or present readings.	Toggles in and out of MIN MAX mode.	Toggles between volts DC and DC-coupled frequency.
\triangle %	In dwell, steps through number of cylinders (4, 5, 6, 8, and 3). In duty cycle, toggles between negative (-) and positive (+) trigger slope. In MIN MAX, press to display maximum, minimum, or present readings.	Toggles in and out of MIN MAX mode.	Toggles between dwell and duty cycle.
RPM ① ②	Manually changes trigger range, i.e., toggles between two trigger levels. In MIN MAX, press to display maximum, minimum, or present readings.	Toggles in and out of MIN MAX mode.	Toggles between 1 RPM count/spark (RPM1) and 2 RPM counts/spark (RPM2).
Ω ① ②	Manually changes range. In MIN MAX, press to display maximum, minimum, or present readings.	Toggles in and out of MIN MAX mode.	Toggles between ohms and continuity.
$^{\circ}\text{C}^{\circ}\text{F}$	Toggles between degrees Celsius and degrees Fahrenheit. In MIN MAX, press to display maximum, minimum, or present readings.	Toggles in and out of MIN MAX mode.	Toggles between temperature and diode test.
\bar{A} \sim	Manually changes amps dc range. In MIN MAX, press to display maximum, minimum, or present readings.	Toggles in and out of MIN MAX mode.	Toggles between amps DC and amps AC.

Bar Graph

The bar graph shows readings relative to the full scale value of a measurement range.

For example, if the meter is in the "4V" range, the scale goes from 0-4, and each number on the bar graph scale represents 1 V. If the meter is in the "40V" range, the scale goes from 0-40, and each number on the scale represents 10 V.

The range is indicated by a number at the right of the bar graph; polarity is indicated by a plus (+) or minus (-) sign at the left. See Figure 3.

The bar graph turns off when the meter is measuring RPM, duty cycle, dwell, temperature or frequency in the VDC mode. When measuring frequency in the VAC mode the meter displays frequency on the digital display and shows the voltage of the input signal on the bar graph. This allows you to see if a hazardous AC voltage is present.

Some examples of digital readings and their equivalents on the bar graph are shown in Figure 4.

Autorange with "Floor"

For most applications, simply select a function and make the measurement. The meter "autoranges" to the best range for the input signal and displays a reading. Most functions have more than one range (see SPECIFICATIONS). The range is shown at the right of the bar graph.

Note

In MIN MAX autorange is disabled. (See "How to Use MIN MAX")

Each range has a "floor". The meter autoranges above the floor but not below it. To determine the floor, short the test leads; the floor is shown at the right of the bar graph.

When using Fluke accessories (like a dc current clamp or pressure sensor), you may want to lock the meter in a millivolt range in which 1 mV equals 1 unit of measurement (e.g., for pressure measurements, 1 mV could equal 1 psi). See "How to Lock the Meter in a Measurement Range".

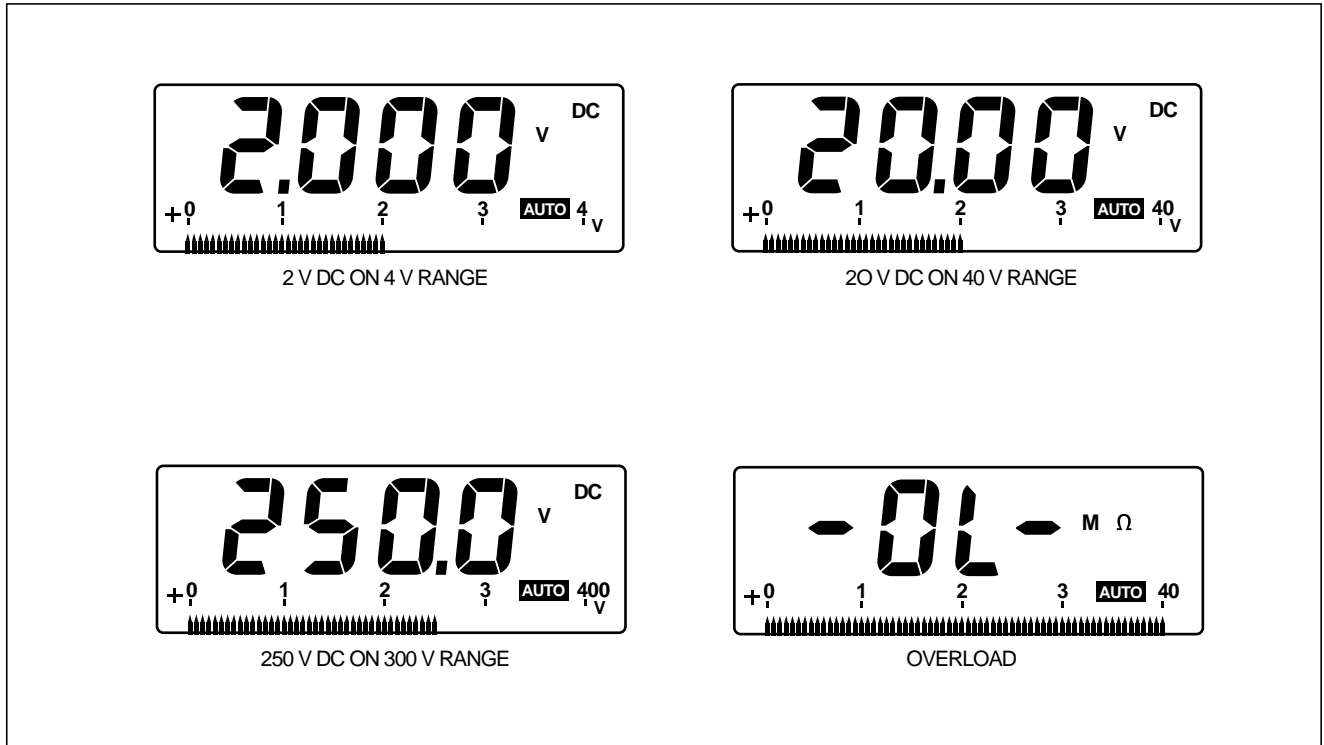

Figure 4. Interpreting the Bar Graph

mi04f.eps

Typical Testing Applications

$\overline{\text{V}}$, $\tilde{\text{V}}$ How to Measure Voltage

Voltage is the difference in electrical potential (charge) between two points.

The following procedure demonstrates how to measure voltage using the example of the no-load voltage of a battery:

1. Insert the test leads into the jacks (Figure 5).
2. Turn the rotary switch to $\overline{\text{V}}$.

Warning

To avoid personal injury or damage to equipment, never attempt a voltage measurement with a test lead in the 10 A input terminal.

Turn the car lights on for 1 minute to bleed off surface charge, then turn lights off.

3. Touch the probes to the circuit. This puts the meter in parallel with the circuit. *Voltage must be measured with the meter in parallel with the circuit.*
4. Read the voltage. If you reverse the probes when measuring dc voltage, the display indicates negative polarity with a minus sign [-]. The no-load voltage only indicates the state of charge, not the condition of the battery.

Note

Use the $\tilde{\text{V}}$ function to measure ripple voltage at the rear of the alternator (not the battery). With the engine running, a good alternator measures less than 0.5 V ac. A higher reading indicates damaged alternator diodes.

A fully charged battery typically shows about 12.6 V.
See other typical values in table below (at 27 °C/80 ° F):

Voltage	% Charge
12.60 V	100
12.45 V	75
12.30 V	50
12.15 V	25

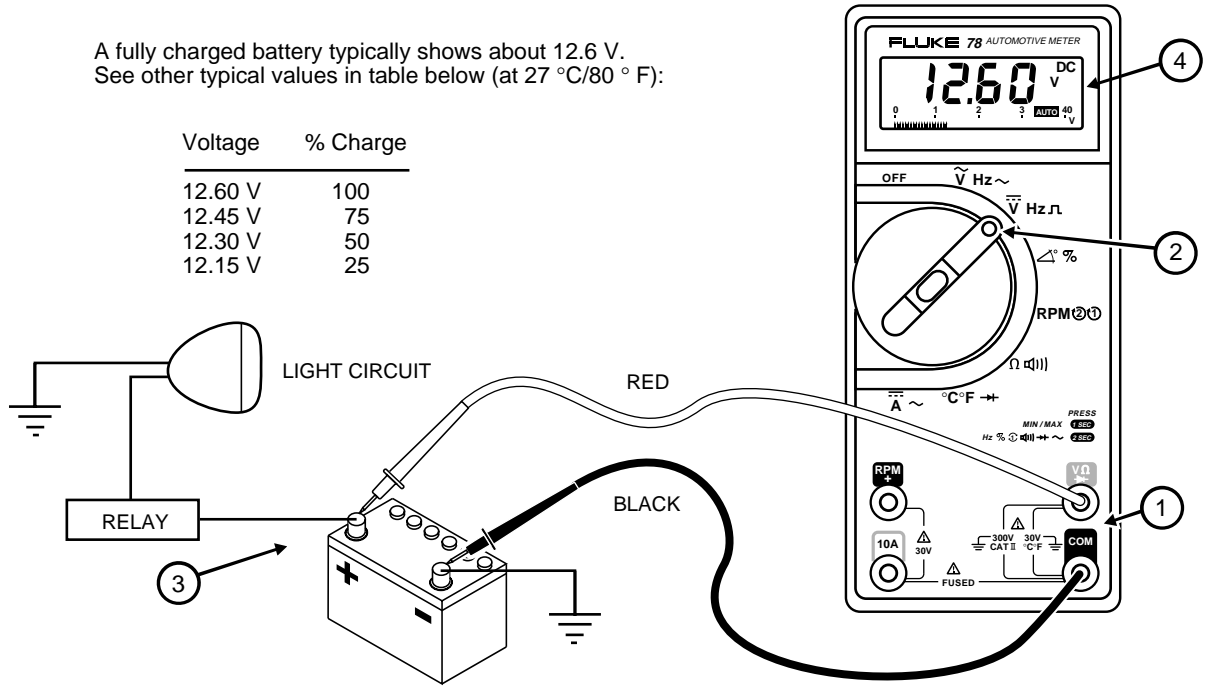

Figure 5. Measuring No-Load Voltage of Battery

mt05f.eps

→| How to Test Diodes

Caution

To avoid possible damage to the meter or to the equipment under test, disconnect circuit power and discharge all high voltage capacitors before measuring resistance, testing for continuity, or diode test.

A good diode allows current to flow in one direction only.

To test a diode, turn the power off, remove the diode from the circuit, and proceed as follows:

1. Insert the test leads into the →| and COM jacks.
2. Turn the rotary switch to →| and press  for 2 seconds

The meter toggles to the diode test function, and  is displayed on the LCD.

3. Touch the red probe to the positive side of the diode and the black probe to the negative side.

The meter displays voltage to approximately 2.5 V. Typical voltage drop for a silicon diode is less than 0.7 V and causes the meter to beep.

4. Reverse the probes and measure the voltage across the diode again.
 - If the diode is good, OL is displayed.
 - If the diode is shorted, near 0 V drop is displayed in both directions, and the beeper sounds continuously.
 - If the diode is open, OL is displayed in both directions.

Figure 6 shows how to check the diodes in an alternator rectifier bridge.

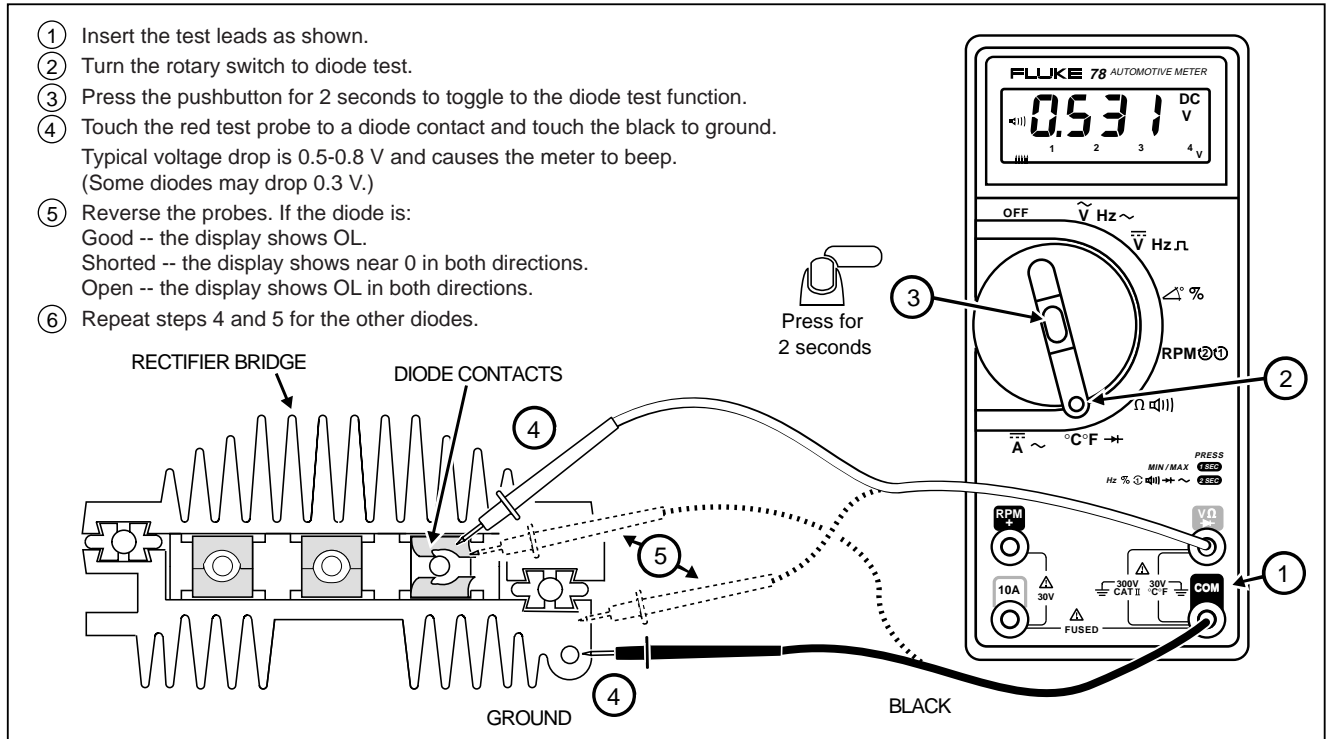

Figure 6. Testing Diodes in Alternator Rectifier Bridge

mt06f.eps

$\overline{\overline{\text{A}}}$, $\text{A}\sim$ How to Measure Current

Warning

To avoid electric shock or personal injury

- **Never attempt an in-circuit current measurement where the open-circuit potential to earth is greater than 300 V.**
- **Before measuring current, check the meter's fuses (see "How to Test the Fuse").**
- **Turn off circuit power before connecting the meter in the circuit. Remember to place the meter in series with the current.**
- **Use proper terminals, function and range for your measurement.**
- **Always use clamp-on probes (dc current clamps) for circuits of more than 10 A.**
- **Install ONLY specified replacement fuses.**

Current is the flow of electrons through a conductor. To measure current:

1. Turn off power to the circuit and break the circuit. (To measure current without breaking the circuit, use a current clamp.)
2. Insert the test leads into the 10 A and COM jacks.
3. Turn the rotary switch to $\overline{\overline{\text{A}}}$. To toggle to $\text{A}\sim$, press  for 2 seconds.
4. Clip the red test lead to the side closest to the power source and clip the black test lead to the side closer to ground.

This puts the meter in series with the circuit being tested and all current flows through the meter. *Always measure current with the meter in series with the circuit under test.*
5. Turn ON power to the circuit and read the display.

Figure 7 shows how to isolate a circuit causing current drain.

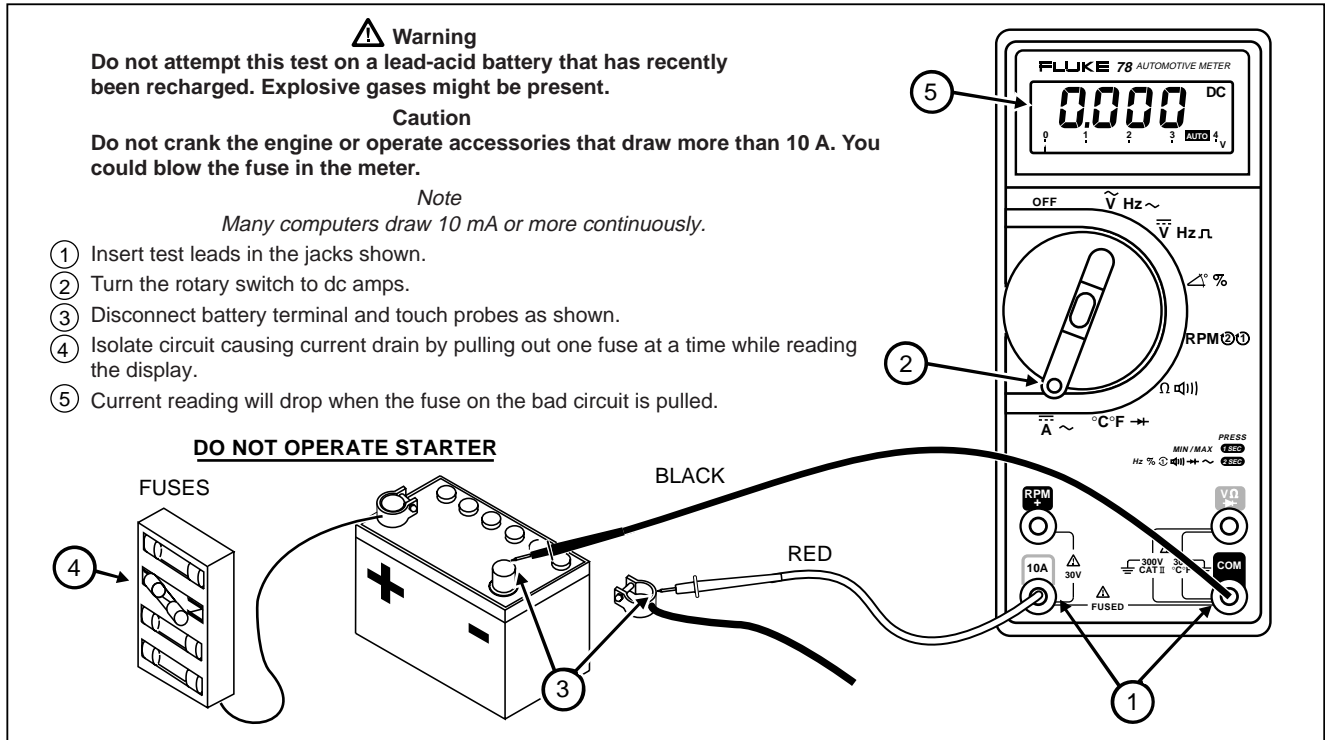

Figure 7. Isolating Circuit Causing Current Drain

mt07f.eps

How to Test Continuity



Caution

To avoid possible damage to the meter or to the equipment under test, disconnect circuit power and discharge all high voltage capacitors before measuring resistance, testing for continuity or diode test.

A continuity test verifies that you have a closed circuit.

The meter detects opens or shorts lasting as little as 1 ms. This is valuable when troubleshooting intermittents associated with cables, connectors, switches, relays, etc.

To check continuity:

1. Turn off power to the circuit.
2. Insert the test leads into the  and COM jacks.
3. Turn the rotary switch to .

4. Press  for 2 seconds.

The meter toggles to the continuity test function, and  is displayed.

5. Touch the probes to the circuit.

Continuity exists if resistance is less than about 30 ohms, and the beeper emits a continuous tone.

Figure 8 shows how to use the continuity test to check a stoplight switch.

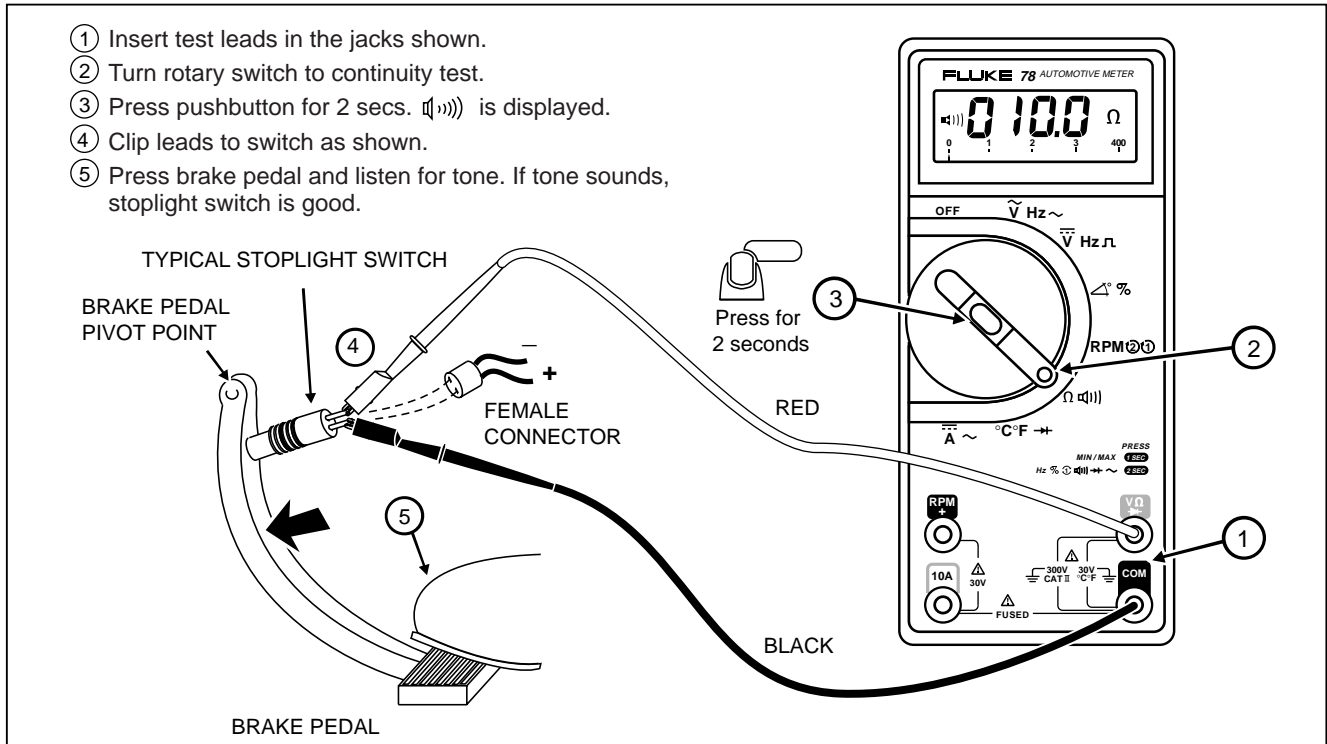

Figure 8. Testing Continuity in a Switch

mt08f.eps

Ω How to Measure Resistance

Resistance hinders the flow of current.

Caution

To avoid possible damage to the meter or to the equipment under test, disconnect circuit power and discharge all high voltage capacitors before measuring resistance, testing for continuity or diode test.

The following procedure demonstrates how to use the resistance function, using a coolant temperature sensor (Figure 9) as an example:

1. Insert the test leads into the Ω and COM jacks.
2. Turn the rotary switch to Ω .
3. Touch the probes to the circuit. Make sure that you have a good contact between the probes and the circuit. Dirt, oil, or other foreign matter affects the resistance.
4. Read the display.

Notes on Measuring Resistance:

The resistance shown on the display is the total resistance through all possible (parallel) paths between the probes. This means that the resistance displayed for an in-circuit resistor can sometimes not correspond to its ohms value.

Resistance in standard test leads is about 0.1 to 0.2 Ω . When measuring low resistances this might be significant and should be subtracted from the display reading.

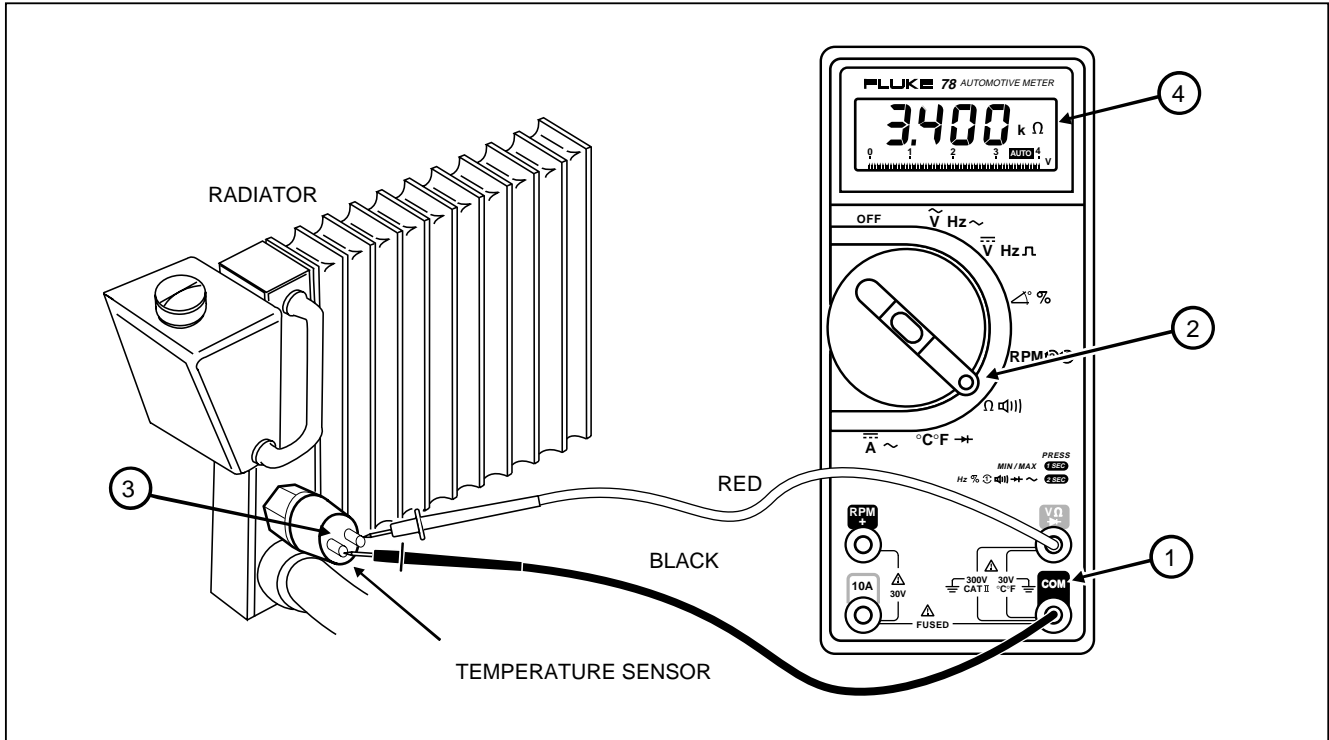

Figure 9. Measuring Resistance to Check Coolant Temperature Sensor

mt09f.eps

RPM How to Measure RPM with the RPM80 Inductive Pickup (Optional)

The RPM80 Inductive Pickup converts the magnetic field created by the current in the spark plug wire to a pulse that triggers an RPM measurement. To measure RPM using the pickup:

Warning

Because the ignition system creates a shock hazard, turn off the engine before connecting or removing the inductive pickup.

Unplug the RPM80 from the meter before measuring voltages above 30 V.

1. Insert the pickup plug into the jacks shown in Figure 10. Make sure the + end of the plug is in the RPM jack.
2. Turn the rotary switch to RPM . The meter has two RPM functions:
 - Use RPM(2) for engines that fire once every two revolutions.
 - Use RPM(1) for engines that fire every revolution or for waste spark, distributorless ignition systems (DIS) -- ie., 1 RPM count/spark.
3. Spread the spark plug wires apart. Clamp the inductive pickup to a plug wire near the spark plug. (In general, the longest wire works best.) Make sure that the jaws are closed completely and the side labeled SPARK PLUG faces the spark plug.
4. Start the engine.

If 0 RPM is displayed, turn OFF the engine and reverse the inductive pickup so that the side labeled SPARK PLUG faces AWAY from the spark plug. Start the engine.
5. To toggle between RPM(2) and RPM(1), press  for two seconds.

The display shows "RPM(2)" or "RPM (1)", depending on the function selected.

Read RPM on the display.
6. **TURN OFF THE ENGINE.** Remove the pickup.

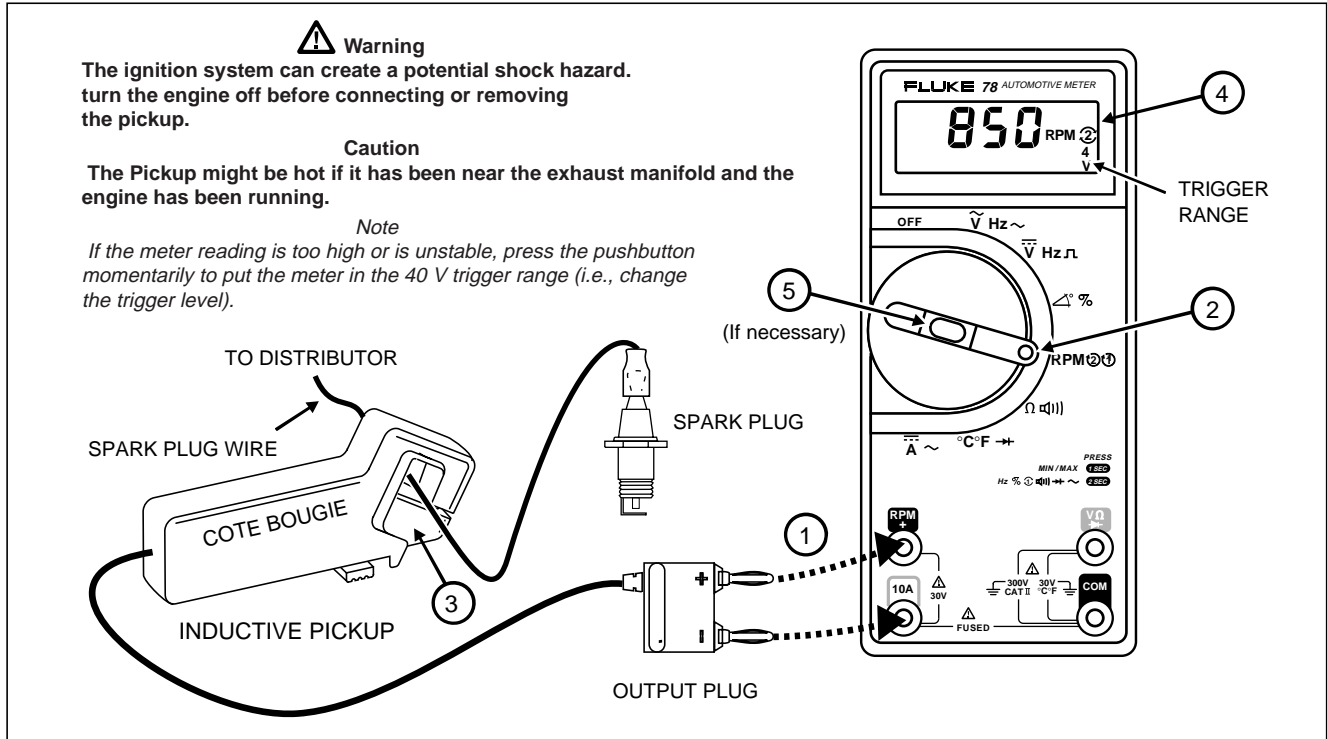



mt10f.eps

Hz **How to Use DC-Coupled HZ to Check BP/MAP Sensors**

Use the dc-coupled Hz function for "pulsed-dc" tests on parts like a mass air-flow (MAF) sensor, a manifold absolute pressure (MAP) sensor, or a Hall sensor.

The following procedure demonstrates how to measure dc-coupled frequency to test a barometric pressure/manifold absolute pressure (BP/MAP) sensor:

1. Insert the test leads into the jacks (Figure 11).
2. Turn the rotary switch to Hz .
3. Press  for 2 seconds to toggle between the volts dc and frequency function.

"DC" and "Hz" show on the display when dc-coupled frequency is selected.
4. Connect the test leads to the jumper wires.

5. With the ignition KEY ON but the ENGINE OFF, pump the vacuum up with a hand vacuum pump.

Watch the frequency change on the display. Compare the frequency at various vacuum readings with the specifications in your car's service manual. At 0 inches-of-Hg, frequency should match the specification for your altitude.

Note

When measuring frequency in VDC, the meter displays frequency on the digital display. The bar graph is turned off and the meter ranging is manual only.

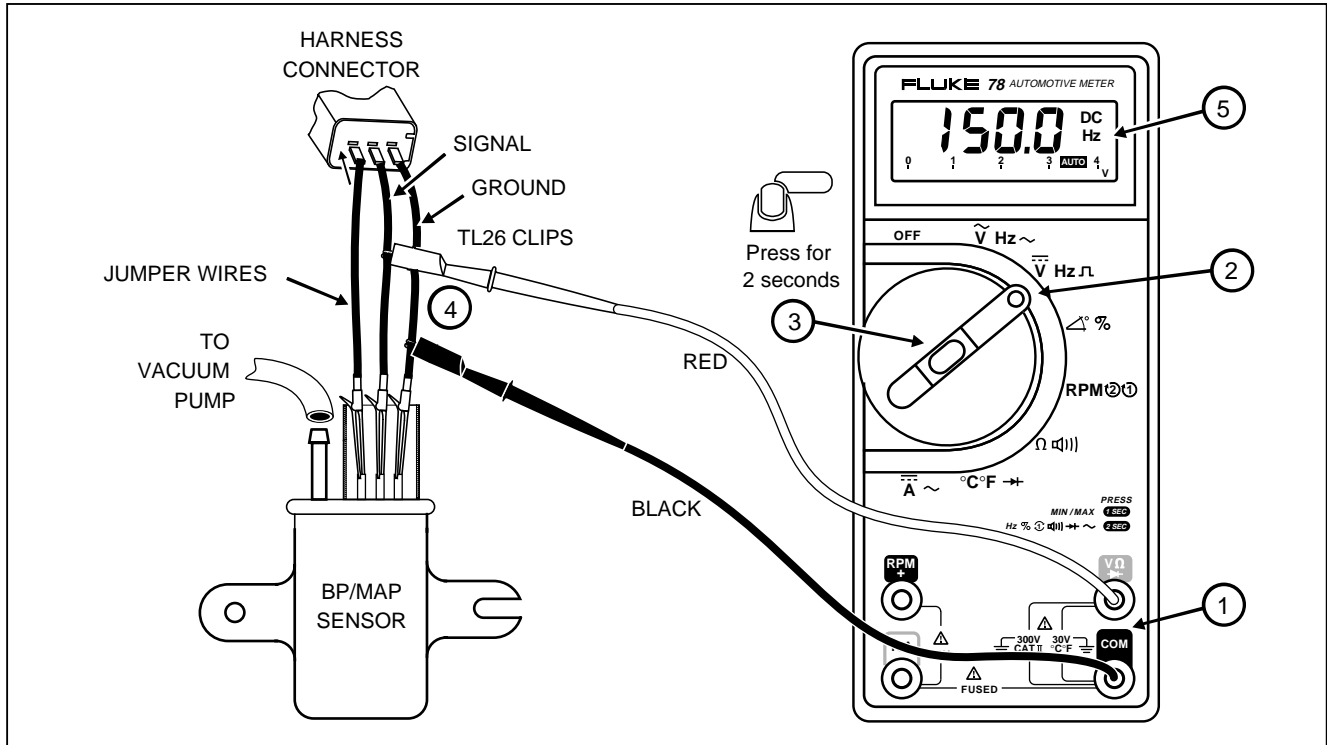



Figure 11. Checking Barometric Pressure/Manifold Absolute Pressure Sensor

mt11f.eps

Hz How to Use AC-Coupled Hz on a Crankshaft Position Sensor

Use the ac-coupled Hz function on parts like crankshaft position or vehicle speed sensors.

The following procedure demonstrates how to measure ac-coupled frequency to test a crankshaft position sensor:

1. Insert the test leads in the jacks (Figure 12).
2. Turn the rotary switch to Hz .
3. Press  for 2 seconds to toggle between the volts ac and frequency functions.

"AC" and "Hz" show on the display when ac-coupled frequency is selected.

4. Connect the test leads to the jumper wires.

5. KEY-ON-ENGINE-OFF. Disable the engine ignition. Crank the motor while watching the display.

Note

When measuring frequency, the meter displays frequency on the digital display and shows the voltage of the input signal on the bar graph. This allows you to see if a hazardous voltage is present.

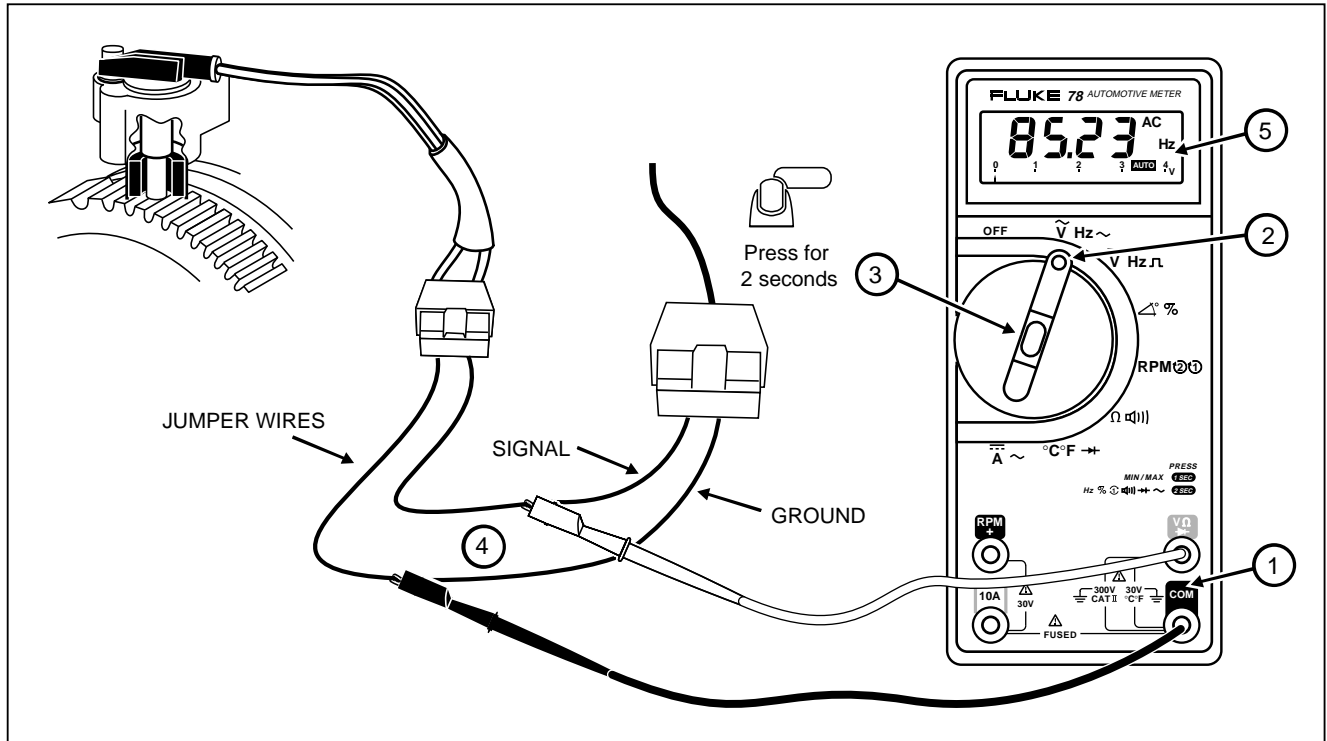

Figure 12. Using AC Coupled-Frequency on a Crankshaft Position Sensor

mt12f.eps

△° How to Measure Dwell on Conventional Ignitions

Dwell is the number of degrees of distributor rotation that the points remain closed or magnetic saturation time.

The following procedure demonstrates how to measure dwell on conventional ignitions.

1. Insert the test leads into the jacks (Figure 13).
2. Turn the rotary switch to \triangle° %.

The meter is in the dwell function. The display shows \triangle° and "OL".

The meter defaults to 4 cylinders when the meter turns on or comes out of standby mode.

3. Press momentarily to step through the number of cylinders (5, 6, 8, 3, and back to 4).

The meter displays the number of cylinders followed by "-CL".

4. Clip the black lead to ground and the red lead to the distributor side (-) of the coil as shown in Figure 13.
5. Start the car. Read the display.

Dwell is displayed in degrees.

Note

The wider the point gap, the less the dwell; the narrower the point gap, the greater the dwell.

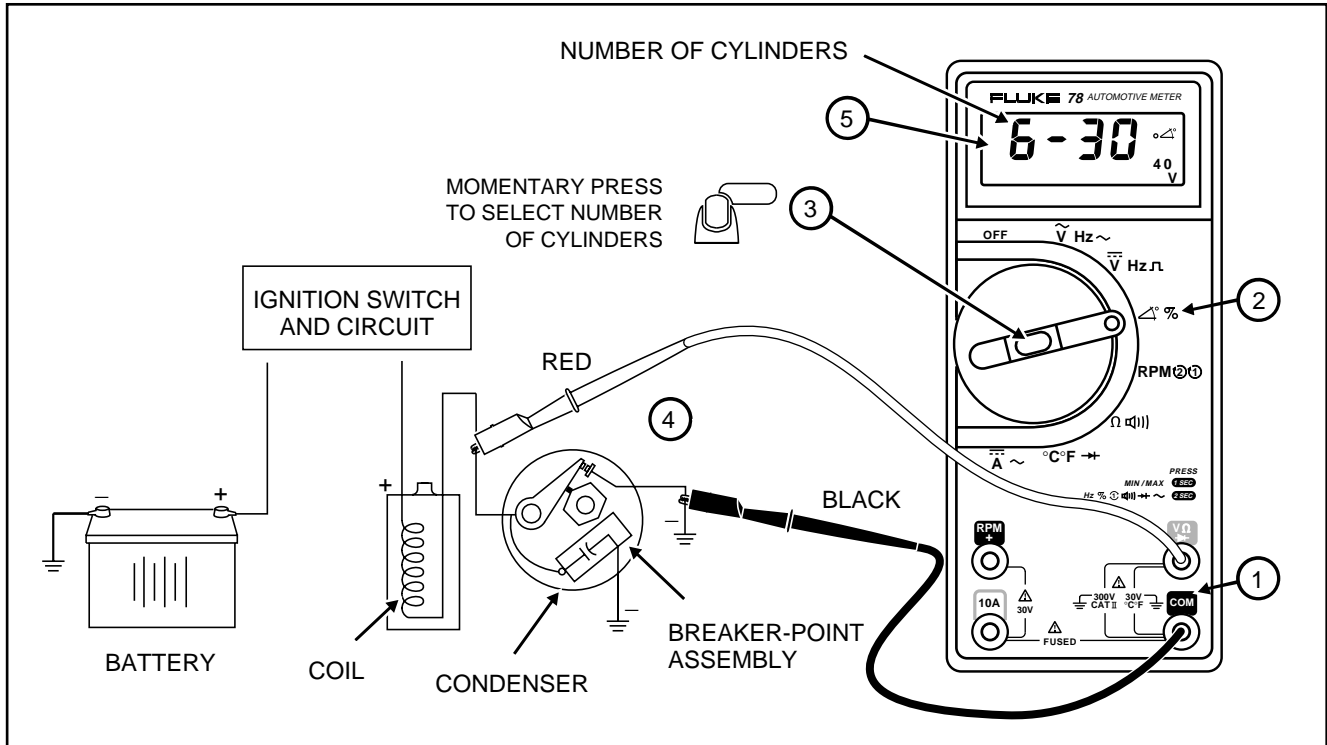



Figure 13. Measuring Dwell on a Conventional Ignitions

mt13f.eps

% How to Measure Duty Cycle on a Feedback Carburetor

Duty cycle is the percentage of time (0-99.9%) a voltage is positive or negative. Most cars have points closed for a duty cycle of 50 to 70%, or mixture control solenoids that are set to 50% in closed loop.

To measure duty cycle on a feedback carburetor:

1. Insert the test leads in the jacks as shown in Figure 14.
2. Turn the rotary switch to %.
3. Press  for 2 seconds to toggle to duty cycle.

When the meter is turned on or comes out of standby (Sleep) mode, the trigger slope is negative (-). The slope is indicated by a + or - sign at the left of the bar graph.

To toggle between a positive and negative trigger slope, press  momentarily.

4. Connect the black test lead to ground and the red lead to the green mixture control test connector (GM cars) at the base of the carburetor.
5. Start the engine and read display when the engine is cold (open loop).

When the engine is in open loop, duty cycle is a steady value. See the car's specifications.

6. Read the display again when the engine is warm (closed loop).

When the engine warms up and goes into closed loop, the reading duty cycle should fluctuate but average 50%.

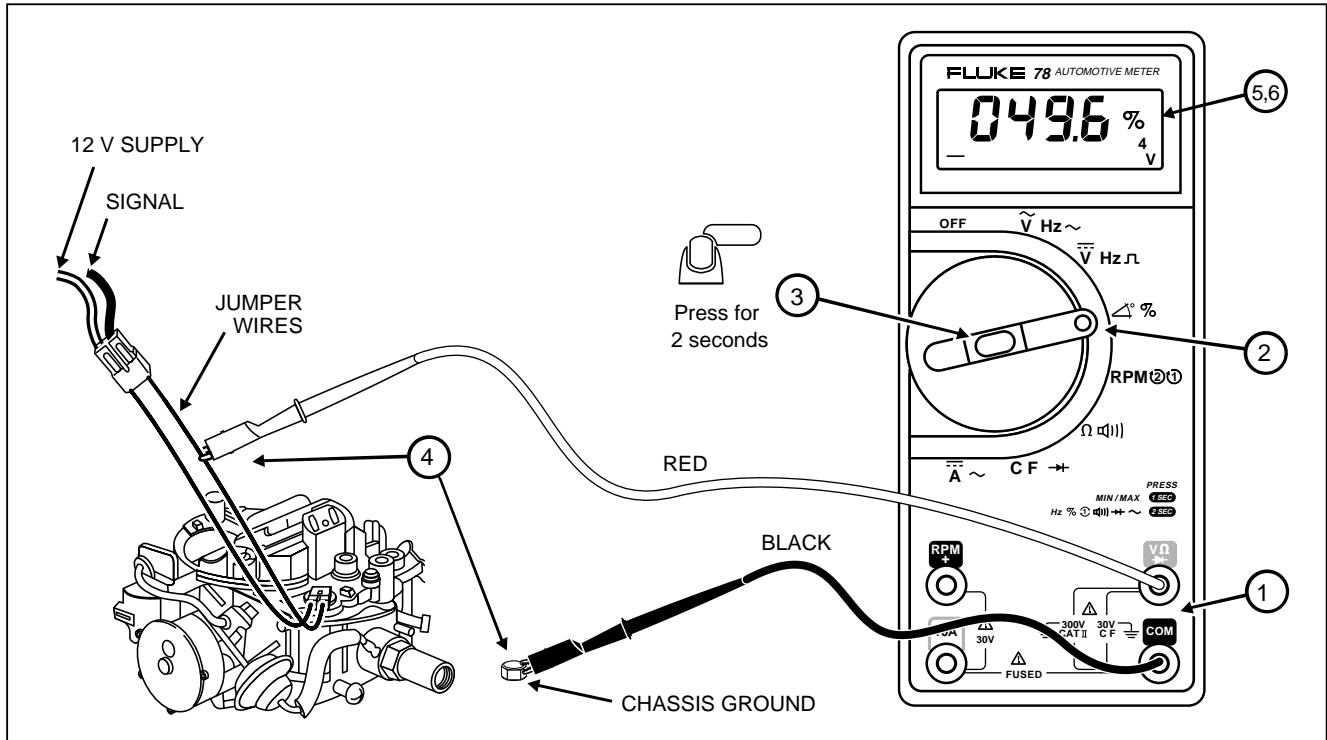

Figure 14. Measuring Duty Cycle on a Feedback Carburetor

mt14f.eps

°C °F *How to Measure Temperature on a Coolant Temperature Sensor*

The Fluke 80BK Thermocouple Adapter that comes with the meter is suitable for making temperature measurements from -40°C (or °F) to 260°C (500°F) in teflon-compatible environments.

Warning

Above this temperature, toxic gas might be emitted. Do not immerse this thermocouple in liquids.

For best results, use the thermocouple probe designed for each application (i.e., an immersion probe for liquid or gel, an air probe for air measurements, etc), and follow the measuring techniques below:

- Clean the measurement surface and make sure the probe is attached securely to the surface.
- When measuring above-ambient temperatures, move the thermocouple on the surface until you get the highest temperature reading.
- When measuring below-ambient temperatures, move the thermocouple on the surface until you get the lowest temperature reading.

- When measuring near-ambient temperatures, take the reading when the display is most stable.

Excessive voltage and strong, low-frequency and radio-frequency fields can reduce the accuracy of temperature readings.

Caution

Do not sharply bend the thermocouple leads. Repeatedly bending the leads can break them.

To measure temperature of a coolant temperature sensor:

1. Plug the adapter with thermocouple into the jacks as shown in Figure 15.
2. Turn the rotary switch to °C °F.

To toggle between Fahrenheit and Celsius, press  momentarily.

3. Attach the thermocouple to the sensor.
4. Read the display.

If the meter detects an open (or no) thermocouple, the display flashes the internal temperature of the meter.

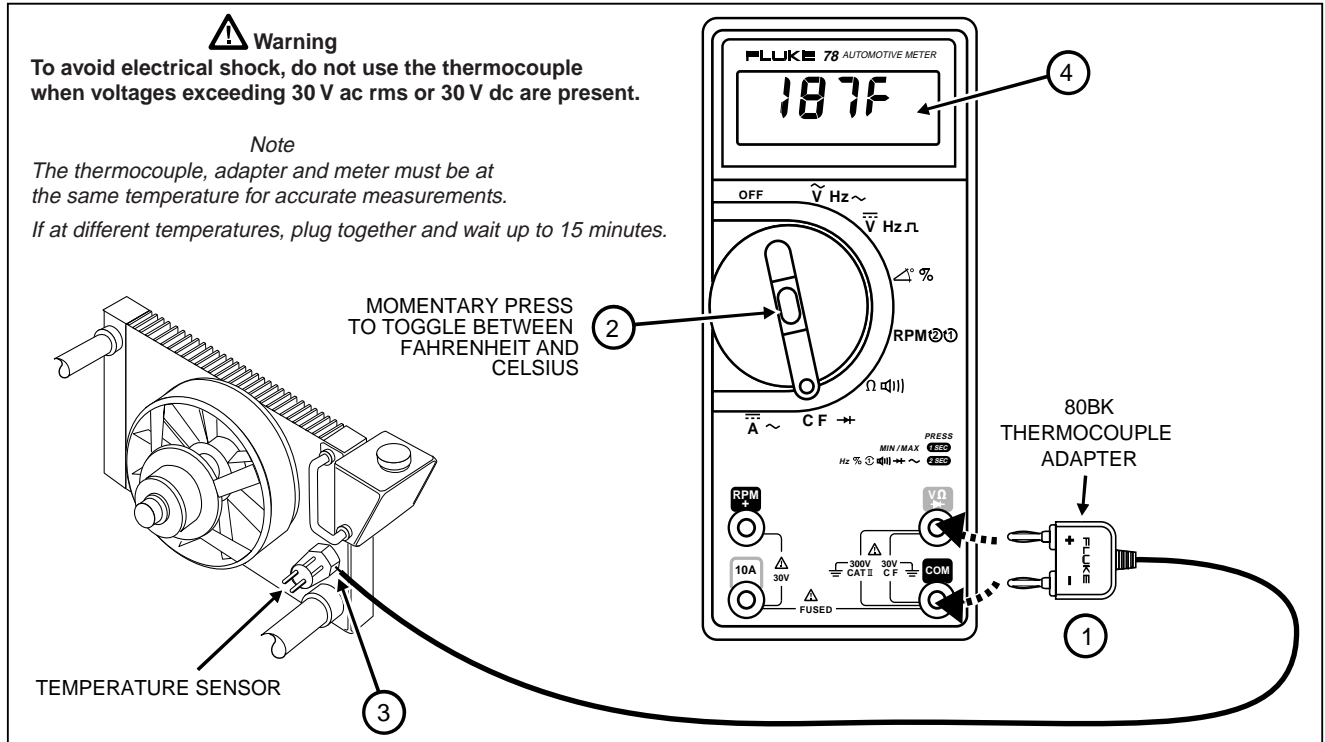

Figure 15. Measuring the Temperature of Coolant Temperature Sensor

mt15f.eps

How to Store Minimum and Maximum Measurements

The MIN MAX function stores the lowest and highest measurements made by the meter. *In MIN MAX auto-ranging and standby are disabled.*

To use MIN MAX:

Note

During MIN MAX operation the beeper will sound continuously if an overrange (O.L.) condition is detected, except in Diode test.

1. Put the meter in a measurement function.
2. *When you put the meter in MIN MAX, you also lock the meter in its present range. Therefore, ensure that the meter is in the desired range before you put the meter in MIN MAX.*

To do so, first take a measurement. Notice the range shown at the upper-right of the bar graph.

3. If the meter is not in the desired range, press  momentarily to step up a range.

Each press steps up a range. After the highest range, the meter wraps to the lowest range.

4. When the meter is in the desired range, press  for 1 second to select MIN MAX.

MAX lights on the LCD, indicating MIN MAX is selected, and the maximum reading is displayed. The beeper sounds when a new minimum or maximum value is recorded.

After MIN MAX is selected, press  to step through the minimum (MIN lights), present (MIN and MAX blink), and maximum (MAX lights) readings.

To exit MIN MAX and erase the stored readings, press  for 1 second or turn the rotary switch. *Because the standby (sleep) mode is disabled, if you do not exit MIN MAX, the meter records minimum and maximum values until the battery goes dead.*

Figure 16 shows how to use MIN MAX to check an oxygen (lambda) sensor.

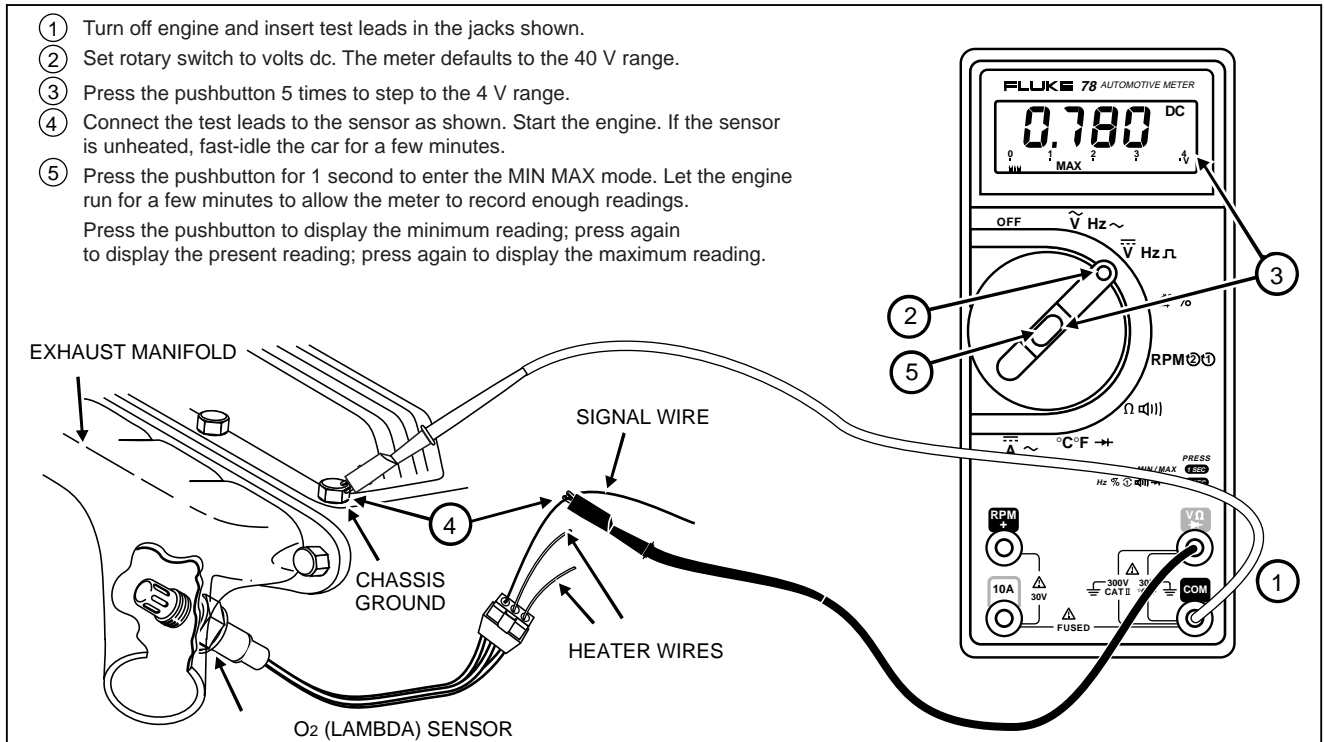

Figure 16. Using MIN MAX to Check an Oxygen Sensor

mt16f.eps

How to Use the Bar Graph to Test a Throttle Position Sensor

The bar graph shows readings relative to the full-scale value of the measurement range. (The range is shown at the right of the bar graph.)

For example, if the meter is in the "4V" range, the numbers on the bar graph scale represent 0, 1, 2, 3, and 4 V. If the meter is in the "40V" range, these same numbers represent 0, 10, 20, 30, and 40 V.

Note

When measuring frequency, the meter displays frequency on the digital display and shows the voltage of the input signal on the bar graph. This allows you to see if a hazardous voltage is present.

To use the bar graph to observe the sweep on a throttle position sensor (TPS):

1. Insert the test leads in the jacks (Figure 17).
2. Turn the rotary switch to Ω .
3. With KEY-OFF/ENGINE-OFF, disconnect the TPS's electrical connector. Then connect the test leads to the sensor as shown.
4. Slowly open the throttle while watching the bar graph.
5. As the resistance increases, the bar graph moves slowly if the TPS is good and moves erratically if the TPS is bad.

Note

With some sensors, the resistance increases above the 4-k Ω range when the throttle opens. If this occurs, the meter autoranges to a higher range, causing the bar graph to wrap. This does not mean that the TPS is bad.

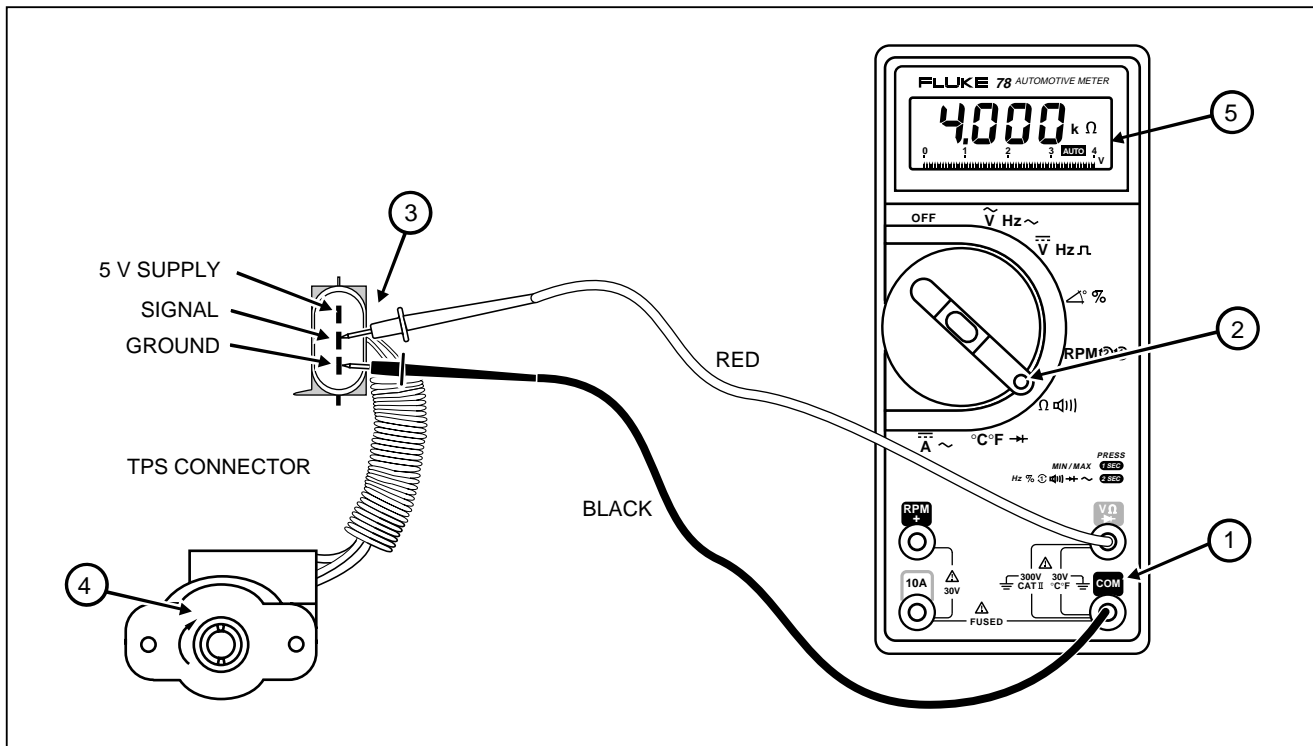

Figure 17. Using Bar Graph to Observe Sweep of Throttle Position Sensor (TPS)

mt17f.eps

How to Lock the Meter in a Measurement Range

The measurement range determines the highest input the meter can measure. Most meter functions have more than one range. See SPECIFICATIONS.

For most applications you can let the meter's autorange function select the best range for the input signal. However, you can disable autorange and lock the meter in a specific range as follows:

1. Put the meter in the desired function.
2. Press momentarily to step up a range.

The range indicator at the right of the bar graph changes. (When measuring resistance, short the test leads to see the range changes.) Notice that the decimal point moves, changing the resolution of the displayed reading.

Each press steps up a range. After the highest range, the meter wraps to the lowest range.

3. When the desired range is selected, press for 1 second to lock the meter in that range.

Note

This also puts you in MIN MAX mode, in which the meter stores the minimum and maximum readings. (See "How to Use MIN MAX" earlier in this manual.)

4. To display the present reading, press twice. Both "MIN" and "MAX" blink when the present reading is displayed.
5. To exit MIN MAX and resume autoranging, press for 1 second or turn the rotary switch.

Using the Holster and Flex-Stand

The snap-on holster with Flex-Stand (Figure 18) absorbs shocks and protects the meter from rough handling. To protect the meter when stored in your toolbox, put the meter in the holster face down.

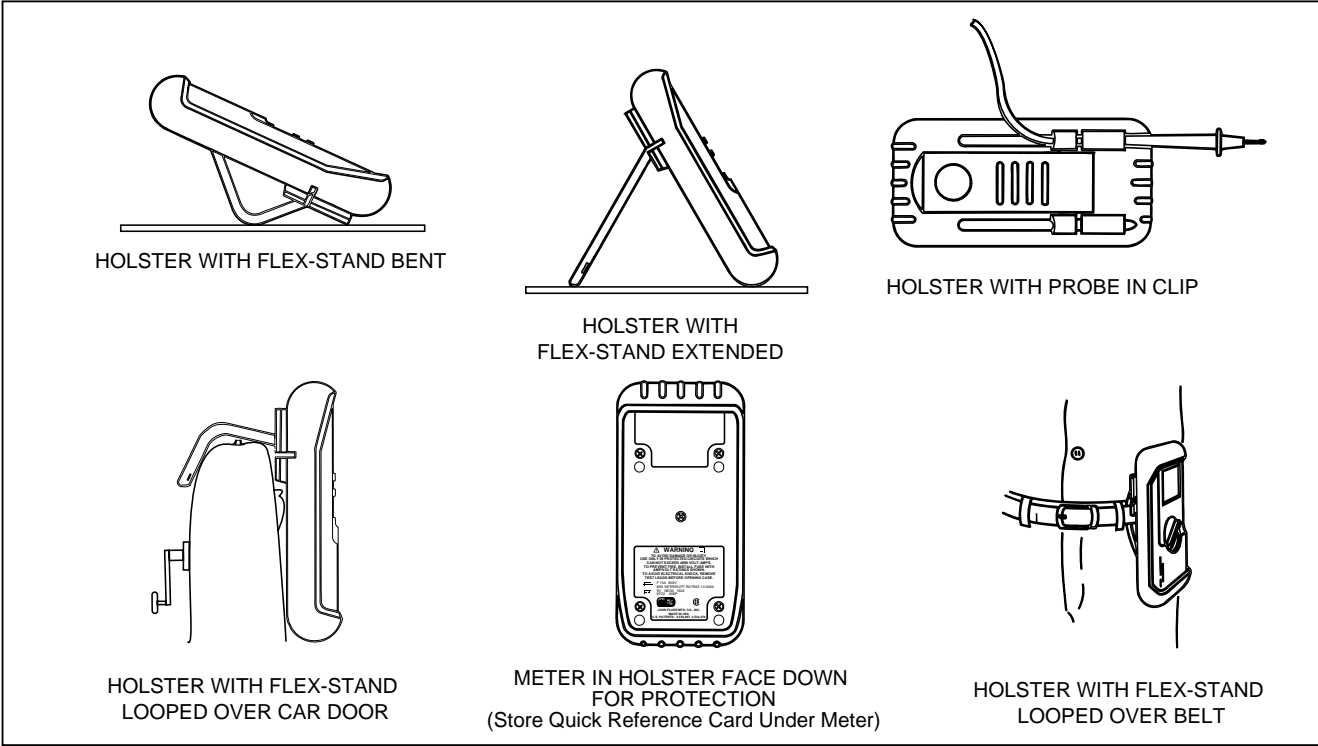

HOLSTER WITH FLEX-STAND BENT

HOLSTER WITH FLEX-STAND EXTENDED

HOLSTER WITH PROBE IN CLIP

HOLSTER WITH FLEX-STAND LOOPED OVER CAR DOOR

METER IN HOLSTER FACE DOWN FOR PROTECTION
(Store Quick Reference Card Under Meter)

HOLSTER WITH FLEX-STAND LOOPED OVER BELT

Figure 18. Holster and Flex-Stand

mt18f.eps

Maintenance

Cleaning

Periodically wipe the case with a damp cloth and detergent; do not use abrasives or solvents.

Calibration

Calibrate the meter yearly to ensure that it meets its performance specifications. Calibration and performance test procedures are in the 78 Service Manual (PN 666617).

How to Test the Fuse

Test the meter's fuse as shown in Figure 19.

How to Replace the Battery or Fuse



Warning

To avoid false readings, which could lead to possible electric shock or personal injury, replace the battery as soon as the battery indicator (⊖+) appears.

To avoid electric shock or personal injury

- **Do not allow water to get inside case**
- **Remove any input signals prior to removing test leads and opening case**
- **When servicing the meter, use ONLY specified replacement parts. See Table 4 for part numbers.**
- **Replace fusible resistor R1 ONLY with specified replacement part.**
- **Install only specified replacement fuses.**

Caution

To avoid damaging components, do not lift the battery straight out. Lift the end of the battery as shown in Figure 20.

Replace the battery and fuse as shown in Figure 20. The meter uses a 9 V battery and a F15 A 600 V fuse. To avoid contamination or static damage, do not touch the rotary switch or circuit board.

For safety, replace the fuse only with a fuse having a minimum interrupt rating of 10 kA (Fluke Part No. 820829). Do not bypass the fuse.

Accessories and Parts

Note

When servicing the meter use only the replacement parts specified in Table 4.

Replacement parts are shown in Figure 21. Parts and accessories are listed in Table 4.

To contact Fluke, call one of the following telephone numbers:

USA: 1-888-99-FLUKE (1-888-993-5853)

Canada: 1-800-36-FLUKE (1-800-363-5853)

Europe: +31 402-678-200

Japan: +81-3-3434-0181

Singapore: +65-738-5655

Anywhere in the world: +1-425-446-5500

Or, visit Fluke's Web site at www.fluke.com.

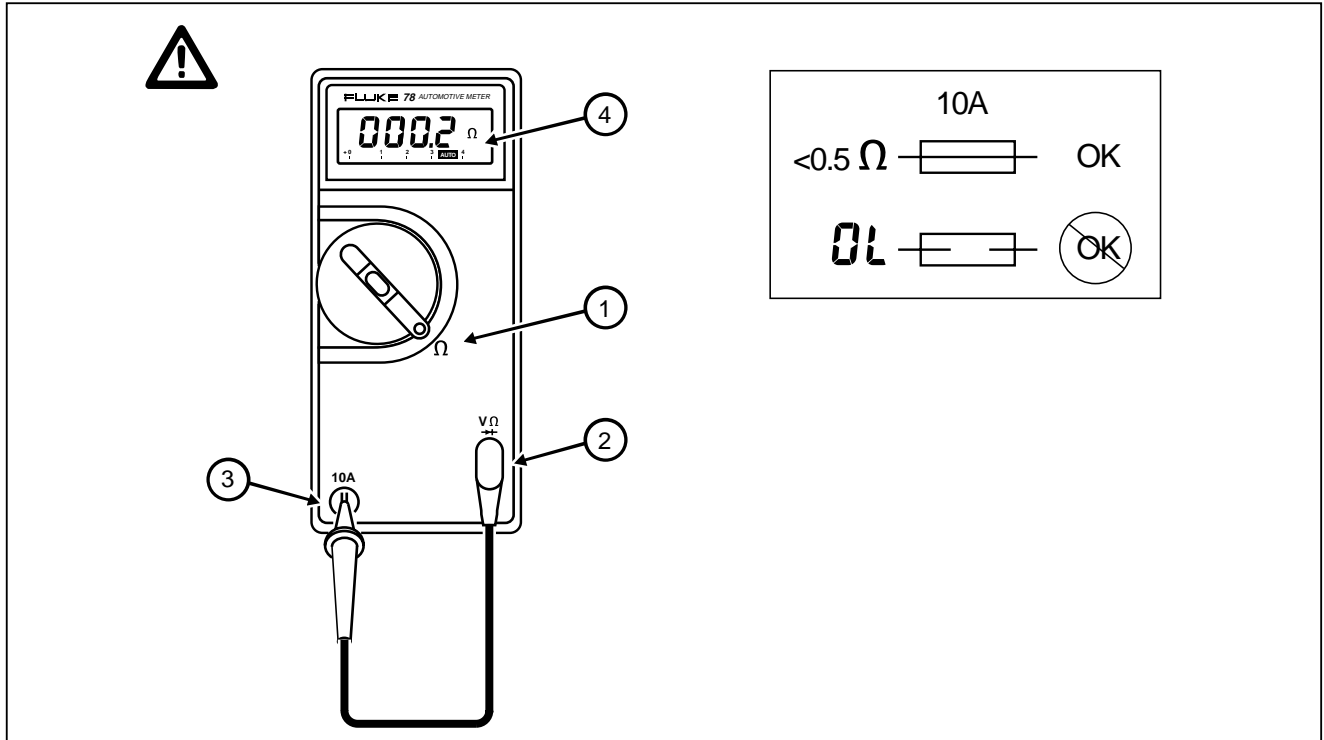

Figure 19. Fuse Test

mt19f.eps

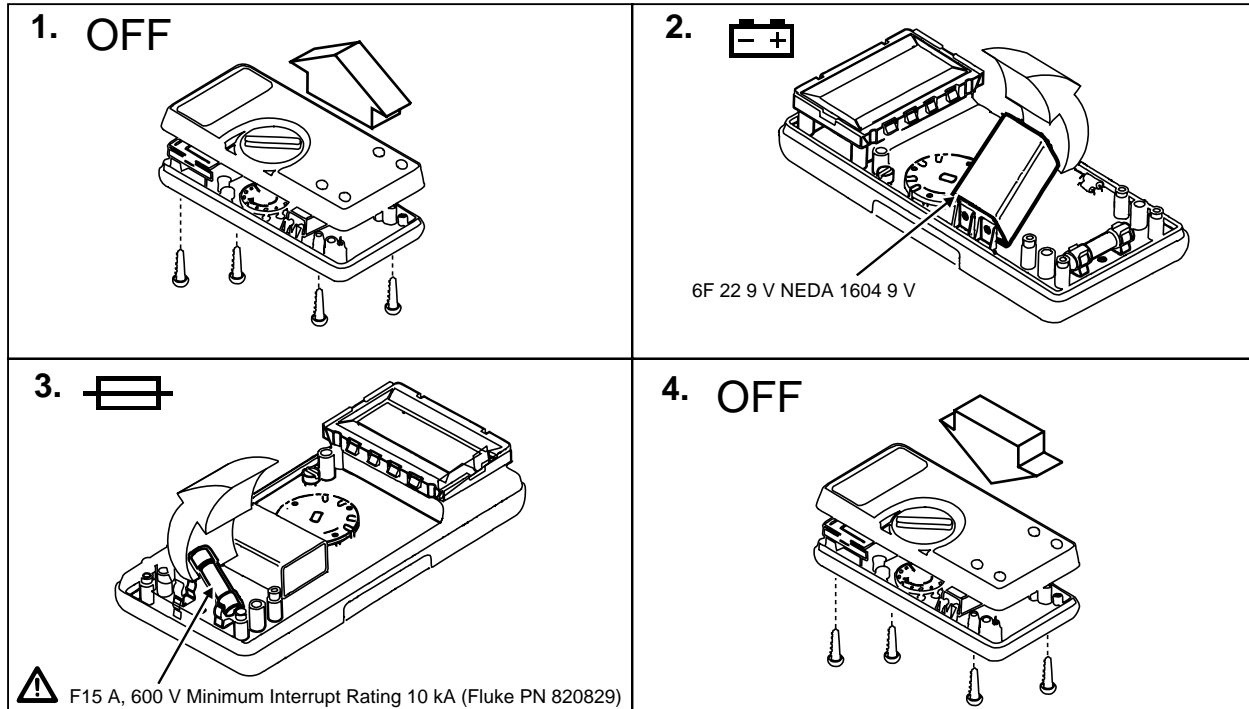



Figure 20. Fuse and Battery Replacement

mt20f.eps

Table 4. Replacement Parts and Accessories

Item	Description	Fluke PN	Qty.
BT1	9 V Battery,0-15 mA	696534	1
F1 	Fuse, F15 A,600 V,Min Interrupt Rating 10 kA	820829	1
H7-10	Screw,Case	733410	4
MP1	LCD Window,Fluke 78	919717	1
R1*	Resistor, Fusible,1k 2W	832550	1
TM1	78 Users Manual (English)	666625	1
TM2	78 Users Manual (European)	666628	1
TM3	Fluke 78 Quick Reference Card	926915	1
TM4	78 Service Manual	666617	1
80BK**	Thermocouple Adapter	—	1
AC70**	Alligator Clips (1 set)	—	1
TL75**	Test Leads, Right-Angle (One Set)	—	1
C70Y**	Yellow Holster	—	1
AC85**	Large Jaw Alligator Clips	—	—
AC89**	Insulation Piercing Clip	—	—
RPM80**	Inductive Pickup	—	—
TL20**	Industrial Test Lead Set	—	—
TL24**	Silicone Insulated Test Leads	—	—
TL26**	5-Way Multipoint Test Lead Set	—	—

* To ensure safety, replace the R1 fusible resistor only with this Fluke-specified part.
 ** Accessory that is normally available through your local distributor.
 To ensure safety, use exact replacement only.

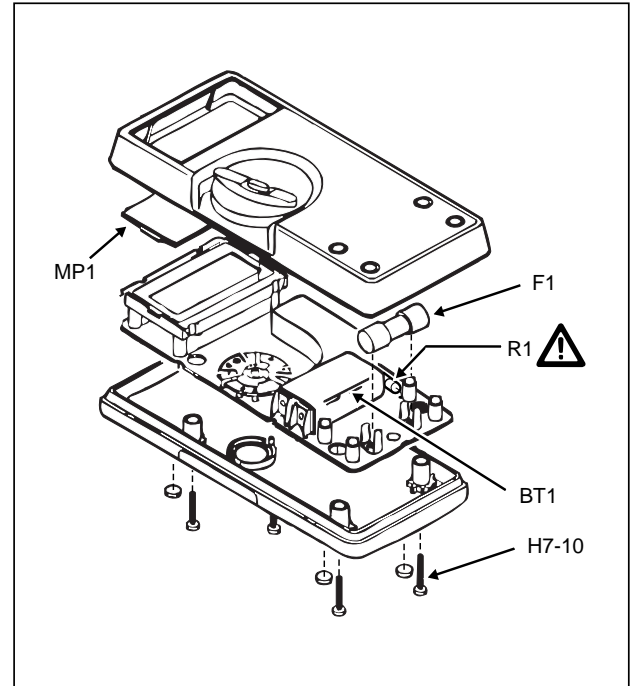

Figure 21. Replacement Parts

mt21f.eps

Specifications

Accuracy is specified for a period of one year after calibration, at 18°C to 28°C (64°F to 82°F) with relative humidity to 90%. AC conversions are ac-coupled, average responding, and calibrated to the rms value of a sine wave input. Accuracy specifications are given as:

$$\pm([\% \text{ of reading}] + [\text{number of least significant digits}])$$

Maximum Voltage Between any Terminal and Earth Ground	300 V	Safety Approvals	CSA Certified, TUV Product Service licensed, UL
Fuse Protection	15 A 600 V FAST Fuse	EMI Regulation	Complies with FCC Part 15, Class B, VDE 0871B, Vfg. 243-1991
Display	Digital: 4000 counts, updates 4/s Bar Graph: 64 segments, update rate 40/s Frequency: 9,999 counts, updates 3/s		This device complies with part 15 of the FCC rules. Operation is subject to the following two conditions: (1) This device may not cause harmful interference, and (2) this device must accept any interference received, including interference that may cause undesired operation.
Operating Temperature	0°C to 55°C (32°F to 131°F)	Inductive Pickup	Input: Magnetic field from sparkplug Output: Pulse to trigger Fluke 78
Storage Temperature	-40°C to 60°C (-40°F to 140°F)	Thermocouple	Type: K (Chromel vs. Alumel) Not suitable for immersion in liquid Accuracy: +/-1.1°C (2°F) between 0°C to 260°C (32°F-500°F).
Temperature Coefficient	0.1 x (specified accuracy) per °C ambient (<18°C or >28°C). When measuring temperature, 0.04% + 0.1°C per °C		Typically within 1.1°C (2°F) of NBS tables for temperatures between -40°C (-40°F) to 0°C (32°F). Temperature Range: -40°C to 260°C. (-40°F to 500°F). Above 260°C (500°F), toxic gas might be emitted NOTE: The temperature range is primarily a function of the thermal limitations of the thermocouple's insulation
Relative Humidity	0% to 95%, to 30°C (86°F) 0% to 75%, to 40°C (104°F) 0% to 45%, to 55°C (131°F)	MIN MAX Recording	Accuracy: Specified accuracy of measurement function +/-16 digits for changes > 200 ms in duration (+/-52 digits in 400 Ω) Nominal Response time (5 to 100% of Range) 100 ms to 80%
Electromagnetic Compatibility	In an RF field of 1 V/m on all ranges and functions: Total Accuracy = Specified Accuracy +0.7% of range. Performance above 1 V/m is not specified.		
Battery Type	9 V, NEDA 1604 or 6F22 or 006P		
Battery Life	Alkaline: 500 hrs (typical) Carbon-zinc:300 hrs (typical)		
Continuity Beeper	4096 Hz		
Shock, Vibration	Per MIL-T-28800 for a Style D, Class 3 Instrument		
Altitude	2000 meters (6562 feet)		
Size (HxWxL)	1.12 in x 2.95 in x 6.55 in (2.8 cm x 7.5 cm x 16.6 cm)		
Weight	12 oz (340g)		
Safety	Complies with ANSI/ISA S82.01-1994, CAN/CSA 22.2 No. 1010.1:1992 to 300 V Overvoltage Category II. UL license pending to UL3111-1. TUV License to EN61010-1.		

Function	Range	Resolution	Accuracy	Burden Voltage (Typical)
AC Volts* (45 Hz to 1 kHz)	4.000 V 40.00 V 300.0 V 300 V —	0.001 V 0.01 V 0.1 V 1 V —	$\pm(2.5\% + 2)$ $\pm(2.5\% + 2)$ $\pm(2.5\% + 2)$ $\pm(2.5\% + 2)$ $\pm 1.5\text{dB typical}$	N/A
DC Volts*	400.0 mV 4000 mV 4.000 V 40.00 V 300.0 V 300 V	0.1 mV 1 mV 0.001 V 0.01 V 0.1 V 1 V	$\pm(0.3\% + 5)$ $\pm(0.3\% + 1)$ $\pm(0.3\% + 1)$ $\pm(0.3\% + 1)$ $\pm(0.3\% + 1)$ $\pm(0.3\% + 1)$	N/A
Resistance	400.0 Ω 4.000 k Ω 40.00 k Ω 400.0 k Ω 4.000 M Ω 40.00 M Ω	0.1 Ω 0.001 k Ω 00.01 k Ω 000.1 k Ω 0.001 M Ω 0.01 M Ω	$\pm(0.5\% + 2)$ $\pm(0.5\% + 1)$ $\pm(0.5\% + 1)$ $\pm(0.5\% + 1)$ $\pm(0.5\% + 1)$ $\pm(1\% + 3)$	N/A
Continuity	400.0 Ω	0.1 Ω	Beeper on @ <30 Ω for short of 1 ms of longer	Open circuit voltage <1.5 V
Diode Test	2.500 V	0.001 V	$\pm 2\%$ typical	Open circuit voltage <3.3 V
AC Current (45 Hz to 1 kHz)	10.00 A**	0.01 A	$\pm(2.5\% + 2)$	0.03 V/A
DC Current	4.000 A 10.00 A**	0.001 A 0.01 A	$\pm(1.0\% + 5)$ $\pm(1.0\% + 2)$	0.03 V/A 0.03 V/A
* Input Impedance: 10 M Ω (nominal), <150 pF> ** 10 A continuous, 20 A Overload for 30 seconds maximum.				

Function	Overload	Input Impedance	Common Mode Rejection Ratio		Normal Mode Rejection Ratio
\tilde{V} , Hz Hz μ	300 V	>10 M Ω <150 pF	>60 dB, dc to 60 Hz		
$\overline{\overline{V}}$	300 V	>10 M Ω <150 pF	>120 dB at dc, 50 Hz or 60 Hz		>60 dB at 50 Hz or 60 Hz
	300 V	>10 M Ω <150 pF			
RPM	30 V	2 M Ω <50 pF			
Ω , $\mu\Omega$)	300 V rms	Open Circuit Test Voltage	Full Scale Voltage		Short Circuit Current
			To 4.0 M Ω	40 M Ω	
		<1.3 V dc	<450 mV dc	<1.3 V dc	<500 μ A
\rightarrow	300 V rms	<3.3 V dc	2.500 V dc		1.6 mA typical
$^{\circ}\text{C}^{\circ}\text{F}$	30 V rms				
† 10 ⁷ V-Hz max					

Function	Range	Resolution	Accuracy
Frequency (1 Hz to 20 kHz) (10^7 V-Hz maximum)	99.9 999.9 9.999 20.00 kHz >20.00 kHz to 99.99 kHz 500.0 kHz	0.01 Hz 0.1 Hz 0.001 kHz 0.01 kHz 0.01 kHz 0.1 kHz	$\pm(0.01\% + 2)$ $\pm(0.01\% + 2)$ $\pm(0.01\% + 2)$ $\pm(0.01\% + 2)$ Usable Usable
RPM1 RPM2	60 - 7,000 RPM (useable to 9.999) 120 - 7,000 RPM (useable to 9,999)	1 RPM 1 RPM	$\pm(0.2\% + 2)$ RPM $\pm(0.2\% + 2)$ RPM
Dwell Angle	0 - 120	1 degree	± 2 degrees
Duty Cycle	0.0 - 99.9% (1 Hz to 20 kHz, pulse width >5 μ s)	0.1%	$\pm(0.2\%$ per kHz + 0.1%) (for rise time <1 μ s)
Temperature*	-40 to +999°C @ >20°C ambient, to +980°C below 20°C ambient	1 degree	$\pm(0.3\% + 6^\circ\text{C})$ @ -40 to -20°C $\pm(0.3\% + 4^\circ\text{C})$ @ -20 to 0°C $\pm(0.3\% + 3^\circ\text{C})$ @ 0 to 170°C $\pm(0.3\% + 5^\circ\text{C})$ @ 170 to 260°C $\pm(0.3\% + 6^\circ\text{C})$ @ 260 to 700°C $\pm(0.3\% + 7^\circ\text{C})$ @ 700 to 999°C
* When measuring temperature, the accuracy of the system is the combined accuracy of the meter and the thermocouple.			

Frequency Counter Sensitivity and Trigger Level

Input Range	Minimum Sensitivity (rms Sine Wave)		Approximate Trigger level (DC Volts Function)
	1 Hz to 5 Hz	5 Hz to 20 kHz	
400.0 mV dc	—	—	400 mV
4000 mV dc	—	—	400 mV
4.000 V	0.7 V	03 V	1.7 V
40.00 V	7 V	3 V	4 V
300.0 V	70 V	30 V	40 V

