

FLUKE®

Biomedical

VT MOBILE

Gas Flow Analyzer

Getting Started Manual

PN 2544892
January 2006

© 2006 Fluke Biomedical. All rights reserved. Printed in USA
Specifications subject to change without notice.

Warranty

Warranty and Product Support

Fluke Biomedical warrants this instrument against defects in materials and workmanship for one full year from the date of original purchase. During the warranty period, we will repair or, at our option, replace at no charge a product that proves to be defective, provided you return the product, shipping prepaid, to Fluke Biomedical. This warranty does not apply if the product has been damaged by accident or misuse or as the result of service or modification by other than Fluke Biomedical. **IN NO EVENT SHALL FLUKE BIOMEDICAL BE LIABLE FOR CONSEQUENTIAL DAMAGES.**

Only serialized products and their accessory items (those products and items bearing a distinct serial number tag) are covered under this one-year warranty. **PHYSICAL DAMAGE CAUSED BY MISUSE OR PHYSICAL ABUSE IS NOT COVERED UNDER THE WARRANTY.** Items such as cables and nonserialized modules are not covered under this warranty

Recalibration of instruments is not covered under the warranty.

This warranty gives you specific legal rights. You may also have other rights which vary from state to state, province to province, or country to country. This warranty is limited to repairing the instrument to Fluke Biomedical's specifications.

Warranty Disclaimer

Should you elect to have your instrument serviced and/or calibrated by someone other than Fluke Biomedical, please be advised that the original warranty covering your product becomes void when the tamper-resistant Quality Seal is removed or broken without proper factory authorization. We strongly recommend, therefore, that you send your instrument to Fluke Biomedical for factory service and calibration, especially during the original warranty period. (When returning the product for any reason, be sure to follow the "Return Procedure" in "Standard Terms and Conditions" in the section in the Operator's Manual called "Notices.")

In all cases, breaking the tamper-resistant Quality Seal should be avoided at all cost, as this seal is the key to your original instrument warranty. In the event that the seal must be broken to gain internal access to the instrument, you must first contact Fluke Biomedical's Technical Assistance Department at 775-883-3400. You will be required to provide the serial number for your instrument as well as a valid reason for breaking the Quality Seal. You should break this seal only after you have received factory authorization. Do not break the Quality Seal before you have contacted us. Following these steps will help ensure that you will retain the original warranty on your instrument without interruption.

Manufacturing Location

The VT MOBILE is manufactured in Everett, WA, USA.

Table of Contents

Title	Page
Introduction	1
Unpacking the VT MOBILE	1
Operation, Storage, and Maintenance.....	5
Support.....	5
Controls and Indicators	5
Powering Up.....	10
Selecting the Operating Mode.....	10
Printing	10
Using the Keys	11
Setting Up	11
Selecting the Gas Type	11
Selecting the Correction Mode	11
Setting the Breath Detect Threshold.....	12
Setting Zero Warn ON or OFF.....	12
Setting the Date and Time.....	13
Checking Version and Serial Numbers.....	13
Accessing Help.....	13

Making a Measurement More Accurate	13
Warm-up and Zeroing	13
Verifying Oxygen Sensor Calibration	14
Calibrating the Oxygen Sensor	14
Using the Temperature and Relative Humidity Sensor	15
Checking the Barometric Pressure.....	15
Measuring Low Pressure	15
Measuring Low Flow	17
Measuring High Pressure	18
Checking Ventilator Parameters	20
Service	25
Battery	25
Specifications.....	26
General Specifications	26
Measurement Specifications	27
Measurement Parameter Specifications	30
Symbols	33

List of Tables

Table	Title	Page
1.	VT MOBILE Versions	2
2.	Standard Accessories.....	2
3.	Available Accessories.....	3
4.	Controls and Indicators.....	7
5.	Ventilator Parameters.....	22

List of Figures

Figure	Title	Page
1.	Key Available Accessories	4
2.	Controls and Indicators.....	6
3.	Measuring Low Pressure.....	16
4.	Low Pressure Screens	16
5.	Measuring Low Flow.....	17
6.	Low Flow Screens	18
7.	Measuring High Pressure	19
8.	High Pressure Screens.....	20
9.	Checking Ventilator Parameters.....	21
10.	Ventilator Parameter Screens	23
11.	Additional Parameter Screens.....	24
12.	Measuring Airway Pressure.....	24
13.	Changing the Battery.....	25

⚠️⚠️ Warning. Read before using Analyzer.

To avoid personal injury, follow these guidelines:

- Do not use the VT MOBILE in any manner not specified in the Operator's Manual. Otherwise, the protection provided by this product may be impaired.
- When measuring oxygen, always keep all components of test setup well away from open flame or other combustion-starting devices.
- Use in well-ventilated space. Be aware that a gas defined with VT for Windows software as 'User' may be unknown while using the VT MOBILE.
- For high pressure measurements, always turn off gas source before connection or disconnection of VT MOBILE. Be aware that there is no pressure indication on the VT MOBILE screen when VT for Windows software is in control.
- Always press power off on the VT MOBILE and unplug the battery eliminator before cleaning the outer surface.
- Inspect the product, if the instrument appears damaged or appears to operate in a manner not specified in the manual, DO NOT CONTINUE USE. Return the product for service.
- Avoid spilling liquids on the analyzer; fluid seepage into internal components creates corrosion and a potential shock hazard. Do not operate the instrument if internal components are exposed to fluid.
- Do not open this product. There are no user replaceable parts.

⚠ Caution

The VT MOBILE should be calibrated annually. Only qualified technical personnel should perform troubleshooting and service procedures on the VT MOBILE.

Do not expose the system to temperature extremes. Ambient operating temperatures should remain between 10 and 40 °C. System performance may be adversely affected if temperatures fluctuate above or below this range.

Clean only with a damp, lint-free cloth, using a mild detergent, and wipe down gently.

Getting Started Manual

Introduction

This Getting Started Manual provides basic information on the Fluke Biomedical VT MOBILE Gas Flow Analyzer (hereafter referred to as the Analyzer.) Refer to the Operators Manual provided on the CD for complete operating instructions.

Seven language options support the available factory-set versions of the Analyzer. These are identified by the overlay language, as described in Table 1.

The Analyzer is a general-purpose, portable gas flow analyzer with special modes designed specifically for testing mechanical patient ventilators. The Analyzer measures bi-directional flow in both high and low ranges as well as high and low pressure ranges. Not for use in the patient environment.

Unpacking the VT MOBILE

Referring to Table 2, unpack the Analyzer and its accessories from the shipping carton. Identify accessories for your Analyzer with the aid of Table 3 and Figure 1. Check for missing parts. Carefully inspect the unit for damage, such as cracks, dents, or bent parts. If items are missing or any physical damage is apparent, call Fluke Biomedical for assistance. For information on ways to contact Fluke Biomedical, see the section in this manual called "Support." Also, notify the carrier if the damage appears to be the result of a shipping mishap.

Maxtec oxygen sensor distributed by Fluke Biomedical.

Table 1. VT MOBILE Versions

Version	Language Overlay	Part Number
VT MOBILE US	English	2427911
VT MOBILE FRA	French	2553550
VT MOBILE DEU	German	2553561
VT MOBILE ITAL	Italian	2553577
VT MOBILE SPAN	Spanish	2553589
VT MOBILE JPN	Japanese	2553610
VT MOBILE CHI	Chinese	2553605

Table 2. Standard Accessories

Item	Part Number
Accessory Kit	2131367
High-Flow Sensor	2438334
Low-Flow Sensor	2548422
High-Pressure Adapter (Luer to Male Nut/Nipple D.I.S.S. Oxygen)	2548303
Low-Pressure Adapter	2454175
Oxygen Sensor	2448801
Oxygen Sensor Cable 6'	2448051
'T', 15 mm ID, 22 mm ID, 15 mm ID	2457028
VT MOBILE RS232 Cable, 6'	2075257
9 VDC Battery (Alkaline)	614487
Soft Carrying Case	2523995
Information Packet: Getting Started Manual; Quick Reference Card; CD with Quick Reference Card, Getting Started Manual, Operators Manual, VT for Windows (V2.01.00 +)	2544926

Table 3. Available Accessories

Item	Part No.
High-Flow Sensor	2438334
Low-Flow Sensor	2438352
High Pressure Adapter (Luer to Female D.I.S.S. Oxygen)	2548315
High Pressure Adapter (Luer to Male Nut/Nipple D.I.S.S. Oxygen)	2548303
Low-Pressure Adapter	2454175
Oxygen Sensor	2448801
Oxygen Sensor Cable, 6'	2448051
"T", 15mm ID end, 22mm ID end, 15mm ID end	2457028
Temperature and RH Sensor Assembly	2541622

Table 3. Available Accessories (cont.)

Item	Part No.
Accessory Kit for VT MOBILE	2131367
CD, includes: Quick Reference Card, Operators Manual, Getting Started Manual, VT for Windows (V2.01.00 +), other matter.	2558269
Serial Communications Cable (RS232) DB9F to miniature RS232, 6'	2075257
Power Adapter, Universal (USA and International)	2118212
Soft-side Carrying Case	2523995
ACCU LUNG Portable, Precision Test Lung	2387318

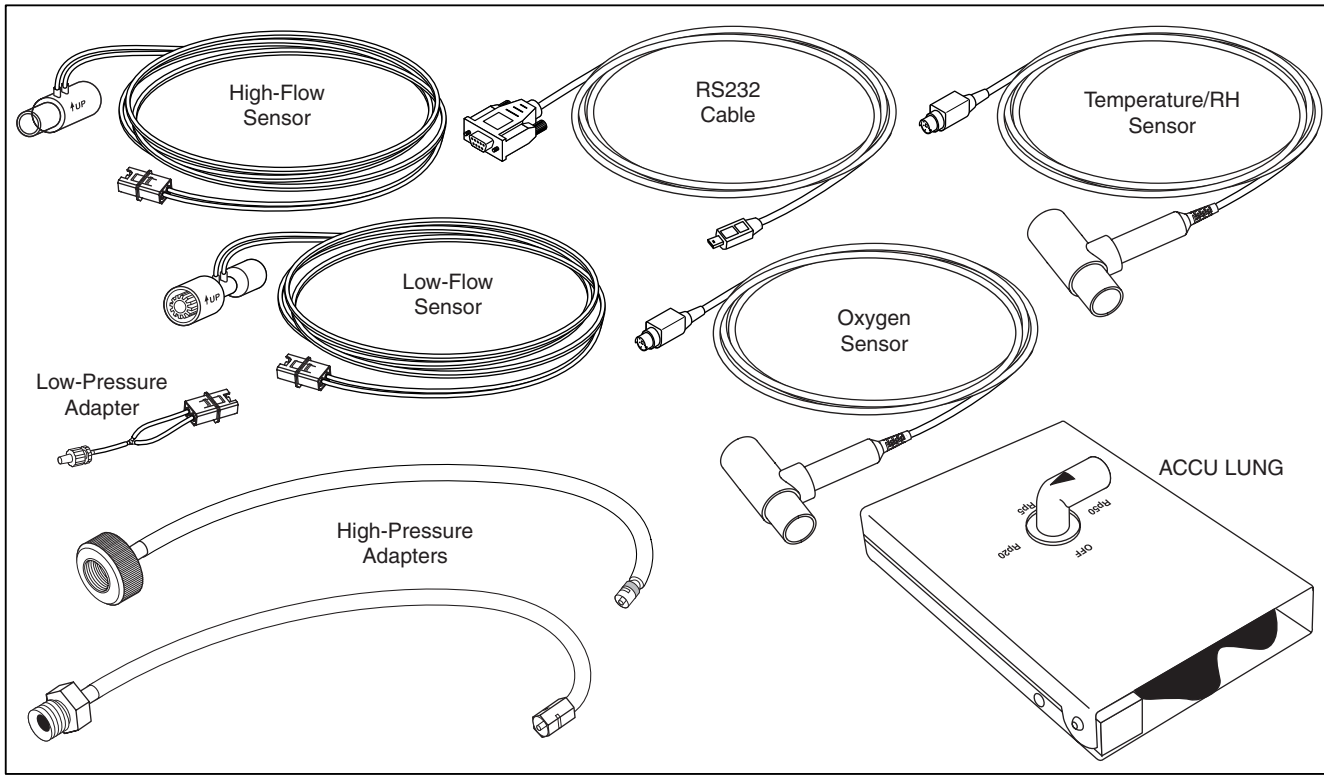

Figure 1. Key Available Accessories

ede03f.eps

Operation, Storage, and Maintenance

Operate the Analyzer in a dry area within temperature limits of 10 °C to 40 °C. The maximum operating relative humidity at temperatures up to 31 °C is 80 % non-condensing, decreasing linearly to 50 % non-condensing at 40 °C.

Store the Analyzer at a temperature of -25 °C to 50 °C and a non-condensing relative humidity of 0 to 95 %.

The battery is the only user-serviceable part in the Analyzer. For safety reasons, maintenance requiring other internal access should be performed only by an experienced technician.

Support

After power-up and connection, if the new Analyzer fails to start or operate successfully, please contact Fluke Biomedical immediately. The Technical Assistance Center is open between 8:00 AM and 5:00 PM, Pacific Standard Time, Monday through Friday, except holidays. When contacting the Technical Assistance Center, please provide the following information: Analyzer version and serial number, specific steps necessary to reproduce the problem, and a phone number where you can be contacted during the day.

Contact Fluke Biomedical in the following ways

Telephone: (800) 648-7952 (in the U.S.A.)

Mail: Fluke Biomedical
6920 Seaway Blvd.
Everett, WA 98206

E-mail techservices@flukebiomedical.com;
sales@flukebiomedical.com

Controls and Indicators

Figure 2 illustrates the controls and indicators found on the front and sides of the Analyzer. Table 4 describes the related call outs.

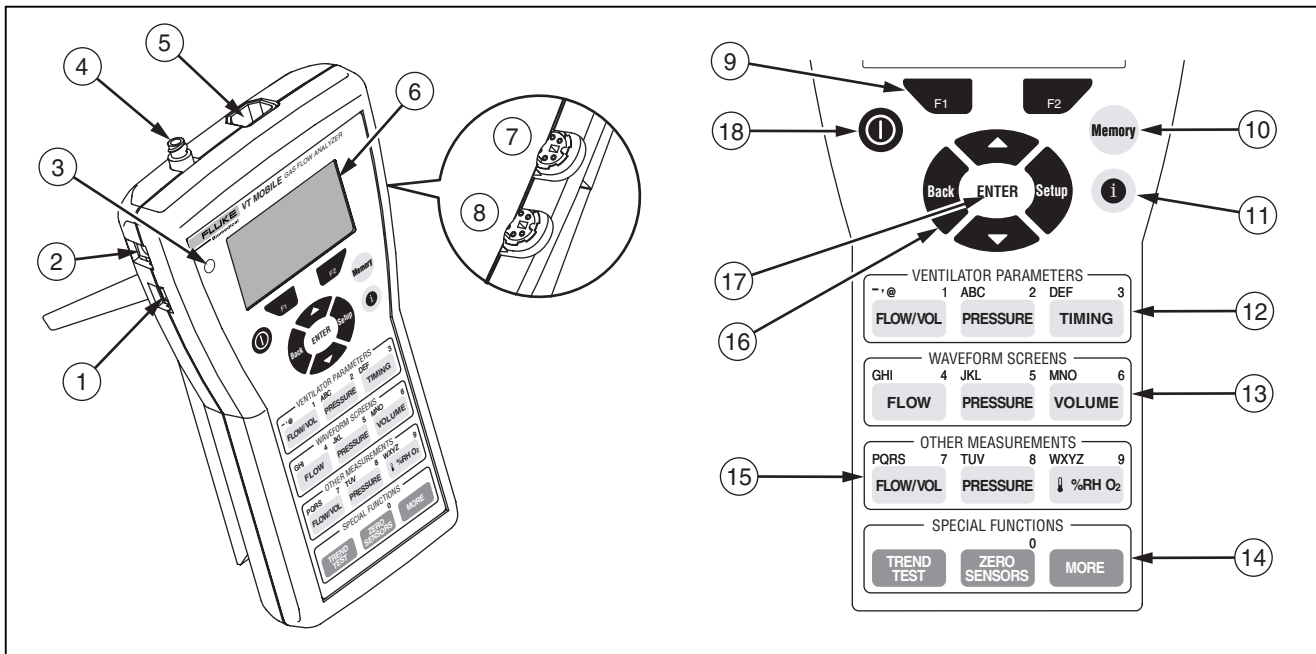

ede01f.eps

Figure 2. Controls and Indicators

Table 4. Controls and Indicators

No.	Name	Description/Use
①	Miniature RS-232 Serial Port	Connect the RS-232 cable here (for use with VT for Windows software.)
②	Battery Eliminator Connector	Connect the battery eliminator here. Use the battery eliminator whenever possible.
③	Battery Eliminator Indicator	Glows green when the battery eliminator is supplying power to the Analyzer. Note that this power source cannot recharge the battery.
④	High Pressure Connector	Connect the High Pressure Adapter here. The Analyzer makes high pressure measurements from -2 to 100 psi.
⑤	Flow and Low Pressure Connector	Insert one of three coded modular connectors here; the Analyzer automatically detects the connector type. The Analyzer use the High-Flow Sensor to measure up to ± 150 lpm, the Low-Flow Sensor to measure up to ± 25 lpm, or the Low-Pressure Adapter to measure from -20 to 120 cmH ₂ O.
⑥	Display Screen	Shows measurement parameters and statistics (Min, Avg, Max), waveforms, and setup selections. English only.
⑦	Oxygen Sensor Connector	Connect the Oxygen Sensor here. The Analyzer makes O ₂ measurements from 0 to 100%.
⑧	Temperature, RH Sensor Connector	Connect the optional Temperature and Relative Humidity Sensor here.

Table 4. Controls and Indicators (cont.)

















































No.	Name	Description/Use
9	Softkeys  	Use  and  to access selections identified on the screen immediately above these keys.
10	Memory Key 	Press  to save, view, or delete memory files. A memory file contains data to reconstruct all aspects of a stored screen (reading, statistics, waveform, parameters, etc.)
11	Help Key 	Press  to access context-sensitive help. If necessary, press  or  to scroll through additional text. Press  to return to the previous screen.
12	Ventilator Parameters Keys   	Press  ,  , or  to display ventilator measurement parameters. When text entry is required, press  successively to cycle through 1 → - → @. Press  to cycle through A → B → C → 2, and press  to cycle through D → E → F → 3.
13	Waveform Screens Keys   	Press  ,  , or  to display specific waveforms. For any waveform, press  (Rescale) to optimize the display or press  (Units) to select new units of measurement. When text entry is required, press  successively to cycle through G → H → I → 4. Press  to cycle through J → K → L → 5, and press  to cycle through M → N → O → 6.

Table 4. Controls and Indicators (cont.)



No.	Name	Description/Use
⑭	Other Measurements Keys 	Press  to access direct readings and statistics of flow and volume. Press  for readings and statistics of high or low pressure. Repeated presses of  yield readings of O2 %, temperature, and relative humidity. When text entry is required, press  successively to cycle through P → Q → R → S → 7. Press  to cycle through T → U → V → 8, and press  to cycle through W → X → Y → Z → 9.
⑮	Special Functions Keys 	Press  to start new or review old trending data. Press  at any time to initiate the zeroing procedure or, when keypad entry is required, to enter 0. Press  to access barometric pressure and battery readings.
⑯	Navigation Keys 	Press  to exit specific screens (Setup, Memory, Help, More, etc.) Press  or  to cycle through specific screen selections (Setup, Memory, More, etc.) or to scroll through help text. Press  to access system settings (Gas Type, Correction Mode, Breath Detect Threshold, Zero Warning, Date, Time, and version numbers.)
⑰	Enter Key ENTER	Press ENTER to activate a menu selection.
⑱	Power Key 	Press and briefly hold this key to power on or power off the Analyzer.

Powering Up

1. Press the Power key (⏻) to power on the Analyzer. The Analyzer displays the power up screen for several seconds.
2. The Analyzer then prompts you for the zeroing procedure. Disconnect flow and pressure sensors and place the Analyzer on a flat surface.

Warning

Make sure pressure is set to zero before disconnecting the High Pressure Adapter. Exposure to high pressure could cause personal injury.

3. Press  (Ok). The Analyzer now performs the zeroing procedure. After several seconds, the Tidal Volume screen appears and the Analyzer is ready for use. If you have pressed  to initiate the zero procedure, the Analyzer returns to the previous screen displayed.

Note

If the Analyzer encounters a power problem (such as a backwards battery), thermal timeout devices interrupt normal operation. Repair the problem, wait several seconds, and resume normal operation.

Selecting the Operating Mode

Local Mode is the default setting upon powering up the Analyzer. In Local Mode, select functions by pressing keys on the front panel.

To change modes from Local to Remote, first connect the serial cable to both the PC and the miniature RS-232 serial port on the Analyzer. Launch VT for Windows software (version 2.01.00 or higher) to activate Remote Mode.

If VT for Windows has remote control, the following appears on the Analyzer display screen:





No Graphics Available, While Communications Are Active

Normal local key presses have no effect. Press  (Cancel) to regain local control.

Printing

Print data from the Analyzer using a PC running VT for Windows. This software also allows you to view all 16 ventilator parameters on one screen and manipulate and graph data.

Using the Keys

Press each key firmly; the Analyzer responds to a recognized key press with a beep. Generally, you can exit one function by selecting another function. Press the  and  navigation keys to cycle through multiple functions accessed from one key. Relevant functions for the two softkeys ( and ) are identified in the display immediately above these keys. When text entry is necessary, quickly press a key to cycle through the characters it accesses. Pause to accept the present character and move to the next entry. Think of text entry as text messaging, as you would encounter on a cell phone.



Note

If the Zero warning screen appears at any time, follow on-screen directions and then press ; the interrupted function will continue automatically after the zeroing procedure.

Warning



Make sure pressure is set to zero before disconnecting the High Pressure Adapter. Exposure to high pressure could cause personal injury.

Setting Up

Press  to access Analyzer settings. (Press  to return to the measurement screen.)



Selecting the Gas Type

Ensure that the gas or gas mixture you will be using is selected, as the gas density will be different for each gas type and mixture.

Select the gas type by pressing  → **ENTER** → **ENTER** →  or  → **ENTER**. Available selections are: Air, O₂, Heliox, CO₂, N₂, N₂O, N₂O/O₂ (N₂O balance O₂), He/O₂ (He balance O₂), N₂/O₂ (N₂ balance O₂), and User. A 'User' gas can only be defined with the VT for Windows software.





Selecting the Correction Mode

Ensure that the correction mode setting matches the one used by the ventilator or anesthesia machine manufacturer for their display of flow and volume measurements. If the correction mode is unknown, select "ATP" (Ambient Temperature and Pressure).

The Analyzer can operate with a correction mode of ATP, STPD₂₁, BTPS, or STPD₀. Select the mode by pressing  → **ENTER** →  (to 'Corr Mode') → **ENTER** →  (to select mode) → **ENTER**.

Setting the Breath Detect Threshold

The default setting of 2.00 lpm is usually appropriate for the ventilators and anesthesia machines being tested. This setting tells the Analyzer how to divide the delivered flow into breaths. If necessary, adjust the Breath Detect Threshold up or down until the breath rate reported on the Analyzer Timing display matches the ventilator breath rate.



Set the threshold by pressing  → **ENTER** →  (to 'BD Thresh') → **ENTER** →  or  (to change threshold in increments of 0.25) → **ENTER**. You can also use keypad entry to directly enter a new value prior to the last **ENTER** press.

Setting Zero Warn ON or OFF



The Analyzer Zero Warn is set to ON at the factory to remind you to zero out any offset in the Flow measurements. The Zero Warn screen reminds you at power on, after the first five minutes, and then after each 30-minute period. After the power-on zero warning, you can choose to Zero or Cancel when the reminder appears; either action returns the Analyzer to the same function.

Warning

Setting Zero Warn to OFF may introduce offset into the Flow and Volume measurements and cause errors in the assessment of those measurements against the medical device under test specification. Fluke Biomedical strongly recommends that you leave Zero Warn ON.



Turn this warning on or off by pressing  → **ENTER** →  (to 'Zero Warn' → **ENTER** →  (to select ON or OFF) → **ENTER**.

Setting the Date and Time





Press  →  → **ENTER** → **ENTER** to access the date setting screen. Using the text entry keys, enter the new date as mm/dd/yy or dd/mm/yy. Then press **ENTER** to accept the change.

At this point, press  → **ENTER** to access the time setting screen. Then use the text entry keys and the softkeys to enter the time, followed by a press of **ENTER**.

Checking Version and Serial Numbers

Press  →  →  → **ENTER** to check the version and serial numbers.

Accessing Help

Use the  key to access context-sensitive help. If additional text is available off screen, a vertical bar appears on the right side of the help screen. Use  or  to scroll through the complete text. Press  to exit help.

Making a Measurement More Accurate

Warm-up and Zeroing

The Analyzer requires a warm-up period. A five-minute warm-up followed by a zero and immediate measurement is adequate for most applications. A 40-minute warm-up ensures maximum accuracy and stability.

The Zero Warn feature reminds you to zero the transducers at predefined intervals. Fluke Biomedical strongly recommends that you leave Zero Warn ON and, after removing pressure and flow sources, zero the transducers whenever the Zero Warn message appears.

The Analyzer requires you to zero immediately after power on. If Zero Warn is ON, the Analyzer prompts you for an optional zero after the first five minutes and then after each subsequent 30-minute interval. To zero at the prompt, place the Analyzer on a flat surface with sensors disconnected at the Analyzer. Then press .

Press  at any time to initiate an unprompted zero.

Generally, it is appropriate to zero before any pressure or flow measurement.

Verifying Oxygen Sensor Calibration

Verify the oxygen sensor calibration at the beginning of any day during which you expect to measure oxygen concentrations. Use the following verification procedure:

1. Connect the Oxygen Sensor as shown in Figure 9.
2. Introduce a 10 lpm or greater flow of 100% oxygen through the Oxygen Sensor "T".
3. Press  to access the O2 display.
4. Ensure that the O2 screen oxygen concentration is 100 % \pm 2 % of full scale. If the concentration is less than 98 %, perform the oxygen sensor calibration as described below.





Replace the oxygen sensor after one year (or longer if no replacement message appears during calibration.)

Note

The Oxygen Sensor is not calibrated at the factory.

Calibrating the Oxygen Sensor

Calibrating the Oxygen Sensor improves pressure compensation for barometric and airway pressure changes.

1. Press  to display the Oxygen measurement screen.
2. Press  to access the Oxygen calibration screen.
3. Connect the High-Flow Sensor and then apply dry air (20.9 % oxygen) at 10 lpm to either side of the sensor.
4. Press  twice to access the Calibration screen. Wait for the two-minute timer to count down.
5. Apply 100 % oxygen at 10 lpm.
6. Press  twice and then press  once to access the Calibration screen.
7. After the two-minute interval, the Oxygen measurement screen appears and the calibration is complete.

Using the Temperature and Relative Humidity Sensor

Use the optional Temperature and Relative Humidity Sensor to compensate for the conditions of the gas under test.

Checking the Barometric Pressure

An internal sensor measures barometric pressure. The Analyzer displays pressure relative to barometric pressure (gauge pressure). Press **MORE** → **ENTER** to check the barometric pressure reading.

To set a different barometric pressure, you can press **F1** and then enter that value with the text entry keys.

Note

The Analyzer relies on ambient barometric pressure. Do not set for airport barometric pressure, which is corrected for altitude.

Measuring Low Pressure

Measure low pressure in the range: -20 to 120 cmH₂O. Never exceed an absolute maximum of 5 psi.

Refer to Figure while following these steps:

1. Press **ZERO SENSORS** and follow on-screen instructions.
2. At the Analyzer, connect the Low-Pressure Adapter to the Flow/Low-Pressure Port.
3. Press **PRESSURE** in the OTHER MEASUREMENTS or WAVEFORM SCREENS section.
4. Verify that the screen displays Low Pressure (Plo) or LPress. If the High Pressure Adapter is also connected, you may need to press **PRESSURE** a second time.
5. Connect the Low-Pressure Adapter to the source.
6. Apply pressure.
7. Successively press **F2** (Units) to select a pressure unit in the sequence: PSI → kPa → Bar → mBar → ATM → inH2O → InHg → cmH2O → mmHg.

If the waveform is too small or too large, press **F1** (Rescale) to view the waveform within optimized limits.

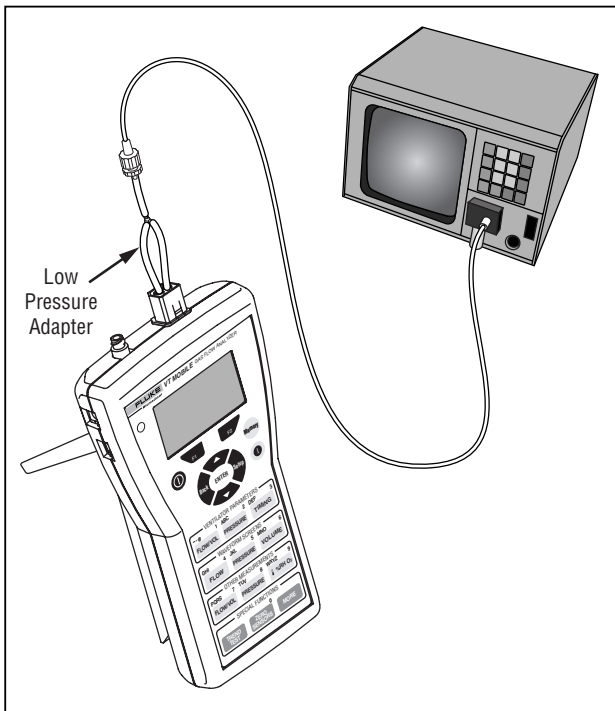
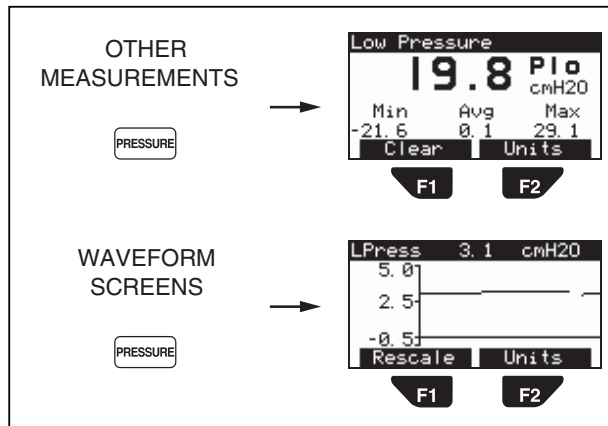

Figure 3. Measuring Low Pressure

ede08f.eps

Figure 4 shows some characteristic low pressure screens.



ede02f.eps

Figure 4. Low Pressure Screens

Measuring Low Flow

Measure low flow in the range: +/- 25 lpm. Never exceed an absolute maximum of 35 lpm.

Refer to Figure 5 while following these steps:

1. Press **ZERO SENSORS** and follow on-screen instructions.
2. At the Analyzer, connect the Low-Flow Sensor to the Flow/Low-Pressure Port.
3. Press **FLOW/VOL** (in OTHER MEASUREMENTS) or **FLOW** (in WAVEFORM SCREENS.)
4. Connect the Low-Flow Sensor to the source.
5. Apply flow.
6. Successively press **F2** (Units) to select a flow unit in the sequence: LPM → CFM → LPS → ml/min → ml/sec.

If the waveform is too small or too large, press **F1** (Rescale) to view the waveform within optimized limits.

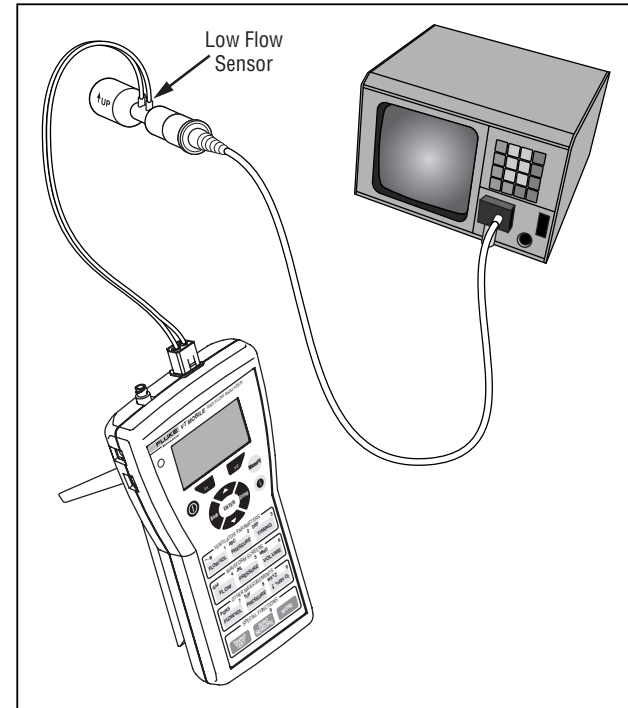

ede13f.eps

Figure 5. Measuring Low Flow

Figure 6 shows some characteristic low flow screens.

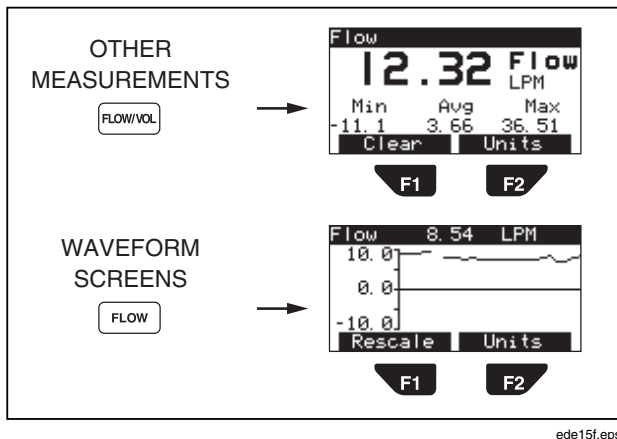

Figure 6. Low Flow Screens

Measuring High Pressure

The Analyzer can measure high pressure from -2 to 100 psi. Be certain of your possible source pressure before measuring high pressure. For example, normal bulkhead outlet pressure could be too high. Unregulated cylinder pressure could also be too high.

Refer to Figure while following these steps:

1. Press **ZERO SENSORS** and follow on-screen instructions.
2. At the Analyzer, connect the High-Pressure Adapter to the High-Pressure Port.
3. Press **PRESSURE** in the OTHER MEASUREMENTS or WAVEFORM SCREENS section.
4. Verify that the screen displays High Pressure (Phi) or HPress. If the Low-Pressure Adapter is also connected, you may need to press **PRESSURE** a second time.
5. With the high pressure source set to zero output, connect the High-Pressure Adapter to the source. Note that various connection schemes are available.
6. Apply pressure.
7. Successively press **F2** (Units) to select a pressure unit in the sequence: PSI → kPa → Bar → mBar → ATM → inH2O → InHg → cmH2O → mmHg.

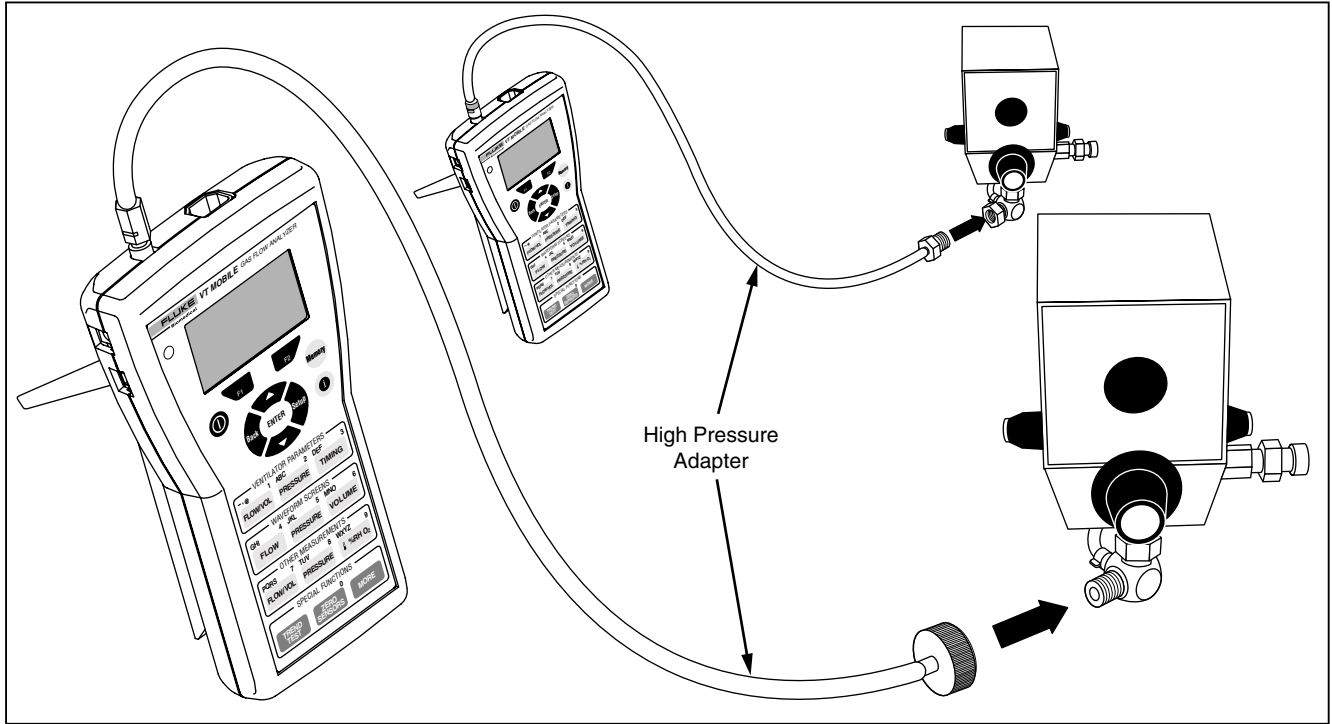

ede11f.eps

Figure 7. Measuring High Pressure

For waveform pressure readings, press **F1** (Rescale) to optimize waveform viewing.

⚠ Warning

Always turn pressure off at the source prior to disconnecting either end of the High-Pressure Adapter. Serious injury could otherwise result.

Figure 0-8 shows some characteristic high pressure screens.

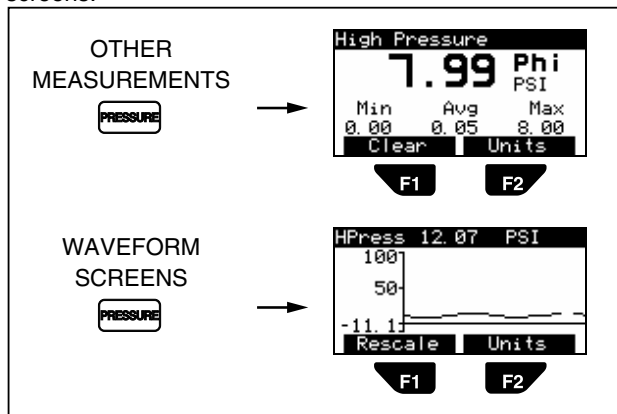

ede04f.eps

Figure 8. High Pressure Screens

Checking Ventilator Parameters

Refer to Figure 9 when you are connecting the Analyzer to a ventilator and test lung.

1. Press **ZERO SENSORS** and follow on-screen instructions.
2. At the Analyzer, connect the High-Flow Sensor to the Flow/Low-Pressure Port.
3. Connect the Oxygen Sensor to the upper port on the right side of the Analyzer.
4. If available, connect the optional Temperature/RH Sensor to the lower port on the right side of the Analyzer.
5. Using parts from the Accessory Kit and the connectors provided with the sensors, make connections between the ventilator and the ACCU LUNG as shown in Figure 9. Use the sequence: ventilator Y connector → High-Flow Sensor (blue stripe toward the ACCU LUNG) → Temperature/RH Sensor → Oxygen Sensor → ACCU LUNG. Vertically align all sensors.
6. Set up the ventilator for a characteristic breath pattern. For example, you could set 10 BPM at 7.5 lpm.
7. Set the ACCU LUNG for C20 compliance (both outer springs engaged) and Rp50 resistance (positioned as shown in Figure 9.)

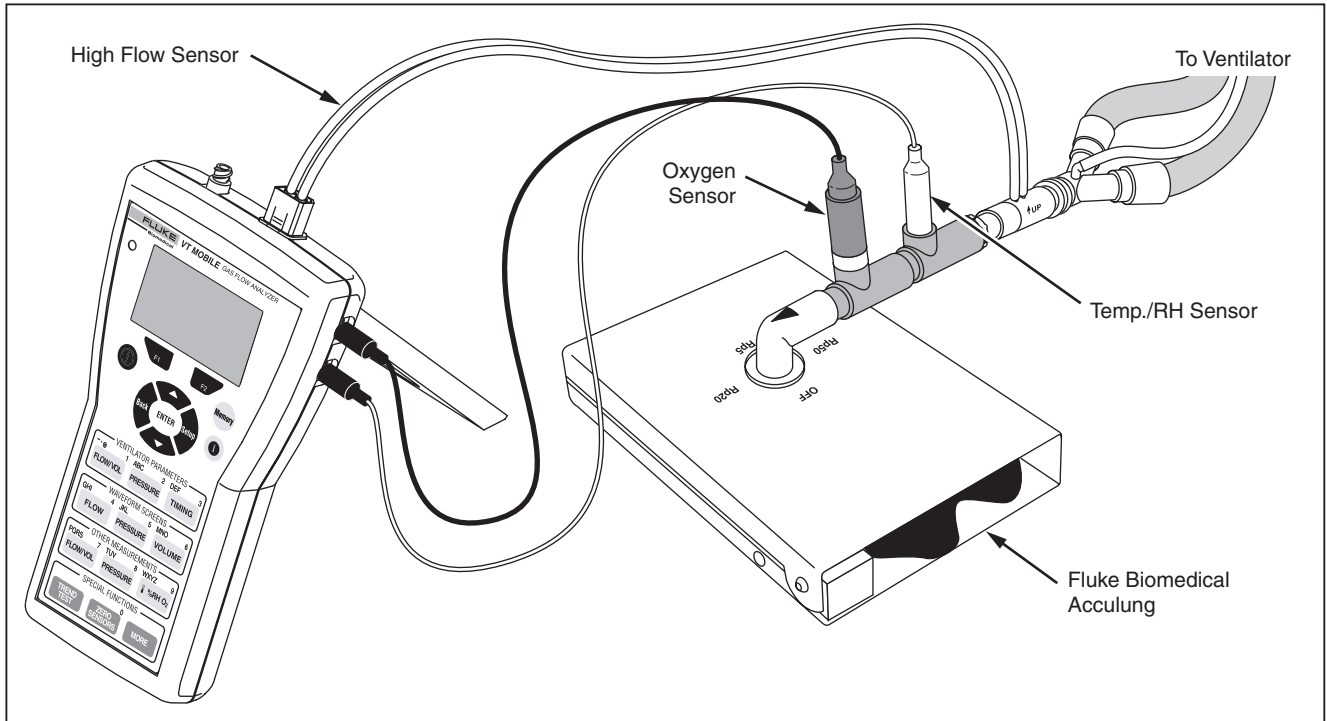





Figure 9. Checking Ventilator Parameters

ede06f.eps

8. Apply power to all elements of the test setup. For the Analyzer, press  on, wait for the Zeroing screen, and then press . The Analyzer is ready to use once the Tidal Volume screen appears.
9. Press the access keys shown in Table 5 to display the various ventilator parameters. Once you have pressed the first key, you can continue pressing that key to view other parameters or press  to view all the parameters.











As described in Table 5, the Analyzer calculates 16 breath parameters in Local Mode. Note that all 16 parameters and other information can be viewed on one screen in Remote mode when using the VT for Windows software.

Figure 10 shows some characteristic ventilator parameter screens.

Figure 11 shows additional oxygen, temperature, relative humidity, and barometric pressure parameter screens.

Figure 12 shows additional airway pressure measurement screens accessible during the ventilator check.

Table 5. Ventilator Parameters

Keys	Item	Name
 	VT	Tidal Volume
	MV	Minute Volume
	PIF	Peak Inspiratory Flow
	PEF	Peak Expiratory Flow
 	PIP	Peak Inspiratory Pressure
	PEEP	Positive End-Expiratory Pressure
	MAP	Mean Airway Pressure
	IPP	Inspiratory Pause Pressure
 	Rate	Breath Rate
	Ti	Inspiratory Time
	Te	Expiratory Time
	I:E	Inspiratory to Expiratory Time Ratio
	O2	Oxygen Percentage
→ 	Temp	Temperature (gas under test)
→ 	RH	Relative Humidity (gas under test)
 ENTER	Baro	Barometric Pressure

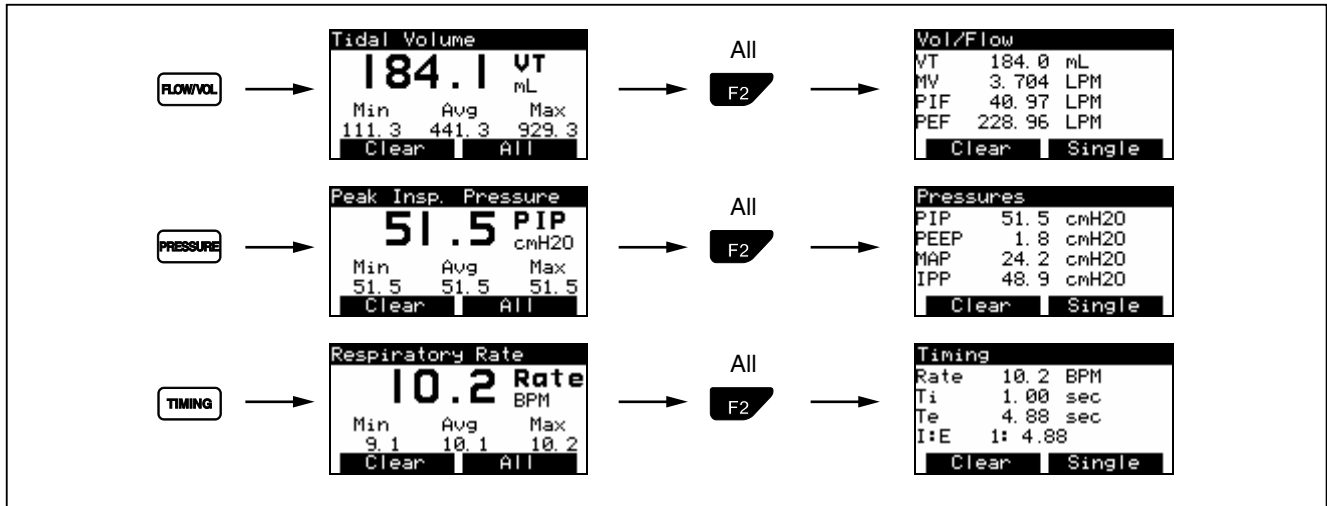

ede07f.eps

Figure 10. Ventilator Parameter Screens

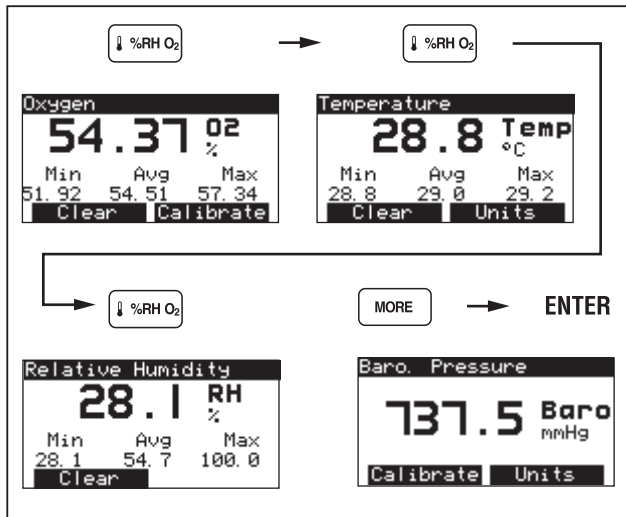

ede12f.eps

Figure 11. Additional Parameter Screens

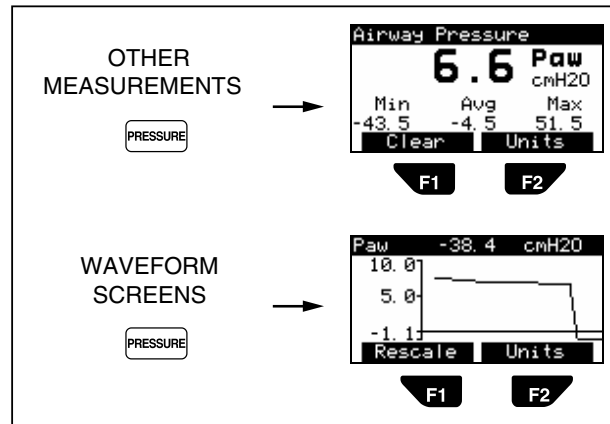

ede05f.eps

Figure 12. Measuring Airway Pressure

Service

Have a qualified technician calibrate the Analyzer once a year. We recommend that you send the Analyzer to a Fluke service center for calibration or service.

Battery

The Analyzer uses a 9-volt, non-rechargeable alkaline battery. Refer to Figure 13 for battery replacement instructions.

If battery voltage drops too low, the message “Warning Your Battery Is Low” appears on the screen. Press **F2** (Ok) to resume viewing the previous display. The Analyzer will now occasionally beep and eventually display the warning screen again, allowing you to repeat the process. However, to maintain accurate measurements, replace the battery as soon as possible after the first warning you notice.

Press **MORE** → **👁** → **ENTER** to check the battery level.

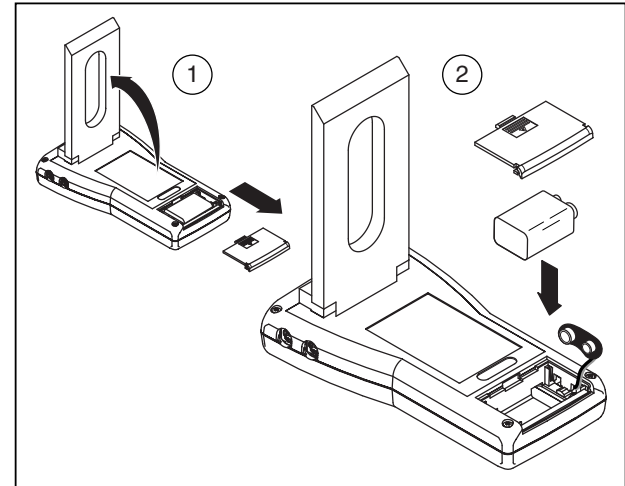

ede09f.eps

Figure 13. Changing the Battery

Specifications

General Specifications

Size:	8 L x 1.5 H x 4 W inches (20 L x 3.8 H x 10 W cm)
Weight:	1 lb (0.45 kg)
Temperature:	Operating: 10 to 40 °C (50 to 104 °F) Storage: -25 to 50 °C (-13 to 122 °F)
Maximum Humidity, Operating:	80 % relative humidity up to 31 °C (88 °F), decreasing linearly to 50 % relative humidity at 40 °C (104 °F).
Maximum Humidity, Storage:	95 %
Barometric:	7 to 18 psia, operating; -1000 to 10000 ft (787.9 – 522.7 mmHg), storage

Battery Power Supply

Voltage:	9 VDC
Power Consumption:	< 70 mA
Battery Life:	> 7 hours

External Power Supply

Output Voltage:	12 – 15 V
Output Current:	1.2 A

Measurement Specifications

Low-Pressure Port

Maximum Applied Pressure:	5 psi
Operating Pressure (Differential):	-20 to 120 cmH ₂ O
Operating Pressure (Common Mode):	NA
Span Accuracy:	± 2 % of reading or 1.5 mmHg, whichever is greater
Frequency Response:	> 10 Hz
Resolution:	0.1 mmHg
Sample Rate:	100 Hz
Fittings:	Flow Connector with 2 tubes "T" connected to a single fitting

Note: No fluid may be applied to port.

High-Pressure Port

Maximum Applied Pressure:	125 psi
Operating Pressure:	- 2 psi to 100 psi
Span Accuracy:	± 2 % of reading or ± 0.2 psig, whichever is greater
Frequency Response:	> 10 Hz
Resolution:	0.1 psi
Sample Rate:	100 Hz
Fittings:	Single port, Luer lock, stainless steel

Note: No fluid may be applied to port.

Airway Pressure

Maximum Applied Pressure:	5 psi
Operating Pressure:	- 20 cmH ₂ O to 120 cmH ₂ O
Span Accuracy:	± 2 % of reading or ± 2.0 cmH ₂ O, whichever is greater
Frequency Response:	> 25 Hz or t ₁₀₋₉₀ < 40 ms
Resolution:	0.1 cmH ₂ O
Sample Rate:	100 Hz
Fittings:	Internally connected to flow sensor pressure lines

High-Flow Port

Maximum Flow Rate (absolute value):	200 lpm
Operating Flow Range:	± 150 lpm
Accuracy:	± 3 % of reading or ± 2 % of range, whichever is greater
Floor for Absolute Accuracy:	25 lpm
Resolution:	0.01 lpm
Frequency Response:	> 25 Hz or t ₁₀₋₉₀ < 40 ms
Sample Rate:	100 Hz
Dynamic Resistance:	< 2 cmH ₂ O @ 60 lpm
Low-Flow Dropout:	2.5 lpm
Breath-Detect Threshold:	4 lpm
Volume Range:	> ± 60 l
Tidal Volume Accuracy:	± 3 % of reading or ± 20 ml, whichever is greater

Maximum Flow Rate (absolute value):	35 lpm
Operating Flow Range:	± 25 lpm
Accuracy:	± 3 % of reading or ± 1% of range, whichever is greater
Floor for Absolute Accuracy:	3 lpm
Resolution:	0.01 lpm flow > 1 lpm
Freq. Response:	> 25 Hz or t_{10-90} < 40 ms
Sample Rate:	100 Hz
Dynamic Resistance:	< 2.5 cmH ₂ O @ 5 lpm
Low-Flow Dropout:	0.24 lpm
Breath-Detect Threshold:	1 lpm (user selectable)
Volume Range:	± 60 l
Volume Accuracy:	± 3 % of reading or ± 5 ml

Oxygen Measurement

Range:	0 to 100 %
Accuracy:	± 2 % full-scale output
Resolution:	0.1 % O ₂
Frequency Response:	> 15 s (t_{10-90})
Sample Rate:	100 Hz
Sensor Technology:	Galvanic Fuel Cell
Calibration:	Allows user calibration using air and 100 % O ₂

Notes:

- Automatic partial pressure compensation for barometric and airway pressure changes
- Recommended interval for changing oxygen sensor is one year. However, sensor may last longer. During user calibration of the sensor, the Analyzer can detect if the sensor needs to be replaced.

Barometric Pressure Measurement

Range:	8 to 18 psia (400 to 900 mmHg)
Accuracy:	± 2 % of reading
Resolution:	0.1 mmHg
Frequency	
Response:	< 5 s (t10-90)
Sample Rate:	N/A
Calibration:	Not required; however, device allows user calibration of offset.

Temperature and Relative Humidity

	Temperature	Relative Humidity
Resolution:	0.1 °	0.1 %
Range:	0 – 50 °C	10 to 95 %
Accuracy:	± 1 °C	± 10 % RH
Units:	°C, °F, °K	%

Measurement Parameter Specifications***Inspiratory and Expiratory Tidal Volume (VT)***

Resolution:	0.1 ml
Range:	> 10 l
Accuracy:	± 3 %

Expiratory Minute Volume (MV)

Resolution:	0.001 lpm
Range:	0 to 60 l
Accuracy:	± 3 %

Breath Rate (BPM)

Resolution:	0.1 bpm
Range:	2 to 150 bpm
Accuracy:	± 1 %

Inspiratory, Expiratory Time

Resolution: 0.01 s
Range: 0.25 to 9.99 s
Accuracy: $\pm 2\%$ or 0.1 s

Mean Airway Pressure (MAP)

Resolution: 0.1 cmH₂O
Range: ± 80 cmH₂O
Accuracy: $\pm 3\%$ or 1 cmH₂O

Peak Inspiratory Pressure (PIP)

Resolution: 0.1 cmH₂O
Range: ± 120 cmH₂O
Accuracy: $\pm 3\%$ or 2 cmH₂O

Positive-End Expiratory Pressure (PEEP)

Resolution: 0.1 cmH₂O
Range: - 5 to 40 cmH₂O
Accuracy: $\pm 3\%$ or 1 cmH₂O

Inspiratory Pause Pressure (IPP)

Resolution: 0.1 cmH₂O
Range: ± 120 cmH₂O
Accuracy: $\pm 3\%$ or 2 cmH₂O

Peak Expiratory Flow (PEF)

Resolution: 0.01 lpm
Range: 0 to 150 lpm
Accuracy: $\pm 3\%$ or 1 lpm

VT MOBILE

Getting Started Manual

Peak Inspiratory Flow (PIF)

Resolution: 0.01 lpm
Range: 0 to 150 lpm
Accuracy: $\pm 3\%$ or 2 lpm

Inspiratory Time (Ti)

Resolution: 0.01 s
Range: 0 to 60 s
Accuracy: 0.5 % or 0.02 s

Expiratory Time (Te)

Resolution: 0.01 s
Range: 0 to 90 s
Accuracy: 0.5 % or 0.01 s

Display Screen

64 x 128 pixels, reflective LCD, blue on yellow

Operational Modes

Standalone

Controlled by VT for Windows PC Software (version 2.01.00 or higher)

Gas Types









Air, O₂, Heliox, CO₂, N₂, N₂O, N₂O bal O₂, He bal O₂, N₂ bal O₂ User





Serial Communications Specifications

4-pin miniature RS-232 serial port located on upper-left side of panel

RS232 compatible with the VT for Windows software application (version 2.01.00 or higher.)

Symbols

Symbol	Description
	See Operators Manual.
	Manufacturer's declaration of product compliance with applicable EU directives
	CSA Listing mark
 12V DC 	Battery Eliminator input
	Do not mix with solid waste stream. Dispose of using a qualified recycler or hazardous material handler.
 9V NEDA 1604A 6F22 006P	9-volt battery
	Flow Port

Symbol	Description
	Pressure Port
	Temperature and Relative Humidity Port
	Oxygen Sensor Port
	Battery Eliminator Port
IOIO	Miniature RS232 Port

